

RADIO CRAFT

...LAR ELECTRONICS ▾



ELECTRONIC MEGAPHONE
SEE PAGE 464

ALEX
CHOMBURG

RADIO-ELECTRONICS IN ALL PHASES

When life or death is a matter of Split Seconds

"HANDIE-TALKIE"
Delivers

In a war of vast spaces, swift movement and violent action . . . Radio Communication must not fail. The front line scout, spotting the location and strength of the enemy, gets his vital information back to the command post with split second speed via the Handie-Talkie, the bantam-weight portable two-way radiotelephone. The signalman talks, giving information . . . and listens, receiving instructions.

The Handie-Talkie was conceived and developed by Motorola, makers of Motorola Radios for Home and Car, Automatic Phonograph-Radios and E-M Police Radiotelephone Systems.

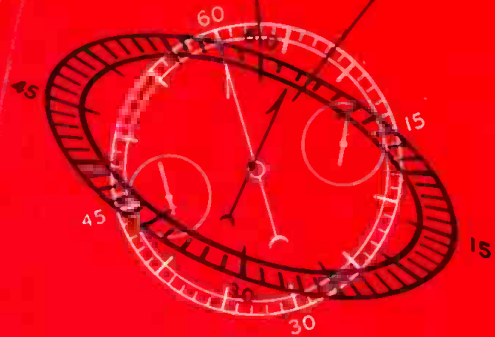

HANDIE-TALKIE
IS ANOTHER
Motorola
Radio
"FIRST"



A FREE LESSON SHOWED BILL HOW HE COULD MAKE GOOD PAY IN RADIO!



I will send you a Lesson on Radio Servicing Tips **FREE** TO SHOW HOW PRACTICAL IT IS TO TRAIN AT HOME FOR **GOOD JOBS IN RADIO**

I want to give every man who's interested in Radio, either professionally or as a hobby, a copy of my Sample Lesson, "Radio Receiver Troubles—Their Cause and Remedy"—absolutely FREE! It's a valuable lesson. Study it—keep it—use it—without obligation! And with it I'll send my FREE 64-page, illustrated book, "How to Train at Home and Win Rich Rewards in Radio." It describes many fascinating jobs in Radio, tells how N.R.I. trains you at home in spare time, how you get practical experience with SIX KITS OF RADIO PARTS I send.

You'll see why my easy-to-grasp lessons have paved the way to good pay for hundreds of other men. But even if you never go any further, this Sample Lesson is worth having. I will send it to you without obligation. MAIL THE COUPON!

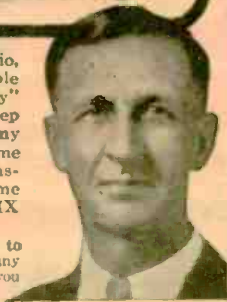

More Radio Technicians Now Make \$50 a Week Than Ever Before

There's a shortage today of capable Radio Technicians and Operators. Fixing Radios pays better now than for years. With new Radios out of production, fixing old sets, which were formerly traded in, adds greatly to the normal number of servicing jobs.

Broadcasting Stations, Aviation and Police Radio, and other Radio branches are searching for Operators and Technicians. Radio Manufacturers employ many trained men. And think of the NEW jobs that Television, Electronics, and Frequency Modulation will open up after the war!

Many Beginners Soon Make \$5, \$10 a Week EXTRA in Spare Time

As soon as you enroll for my Course I start sending you EXTRA MONEY JOB SHEETS that show you how to earn \$5 to \$10 a week EXTRA in spare time while still learning.

Mail Coupon for Free Lesson and Book

The opportunity the war has given beginners to get started in Radio may never be repeated. So take the first step at once. Get my FREE Lesson and 64-page, illustrated book. No obligation. Just mail coupon in an envelope or paste it on a penny postal.—J. E. SMITH, President, Dept. 4EX, National Radio Institute, Washington 9, D.C.

You Build These and Other Radio Circuits with 6 BIG KITS OF PARTS I SEND YOU!

By the time you've conducted 60 sets of Experiments with Radio Parts I supply, made hundreds of measurements and adjustments, you'll have valuable PRACTICAL Radio experience for a good full or part-time Radio job!



MEASURING INSTRUMENT (above) you build early in Course. Use it in practical Radio work to make EXTRA money. Vacuum tube multimeter, measures A.C., D.C., and R.F. volts, D.C. currents, resistance, receiver output.



A. M. SIGNAL-GENERATOR (left) build it yourself! Provides amplitude-modulated signals for test and experimental purposes. Gives valuable practice!

SUPERHETERODYNE CIRCUIT (right) Preselector, oscillator-mixer-first detector, i.f. stage, diode detector—a.v.c. stage, audio stage. Bring in local and distant stations on this circuit you build yourself!



GET BOTH 64 PAGE BOOK **FREE** SAMPLE LESSON

Mr. J. E. SMITH, President, Dept. 4EX, NATIONAL RADIO INSTITUTE, Washington 9, D. C.

Mail me FREE, without obligation, Sample Lesson and 64-page book, "How to Train at Home and Win Rich Rewards in Radio." (No salesman will call. Write plainly.)

Age.....
 Name.....
 Address.....
 City..... State..... 14X1

My Radio Course Includes Training in TELEVISION • ELECTRONICS • FREQUENCY MODULATION

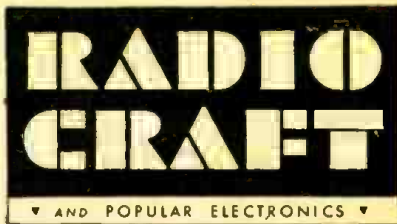

"RADIO'S GREATEST MAGAZINE"



HUGO GERNSBACK, *Editor-in-Chief*
 FRED SHUNAMAN, *Associate Editor*
 G. ALIQUO, *Circulation Manager*



IN THE NEXT ISSUE

Acoustics & Distortion
 Remote Control Systems
 FM-Controlled Vibrator
 Testing Loud-Speakers
 Radio Defensive Reflector



Published by Radercraft Publications, Inc.
 Publication Office: 29 Worthington Street,
 Springfield 3, Mass.
 Editorial and Advertising Offices: 25 West
 Broadway, New York 7, N. Y.
 Chicago Advertising Office: Radio-Craft, 520
 North Michigan Avenue, Chicago 11, Ill.

RADIO-CRAFT is published monthly, on the
 25th of the month preceding that of date; sub-
 scription price is \$2.50 per year in U. S. (In
 foreign countries, 75c additional per year to
 cover postage; Canada, 50c additional.) Spe-
 cial rates for members of the Armed forces
 in U. S., or those addressed by A.P.O. or
 F.P.O. mail, \$2.00. Entered at the post office
 at Springfield as second-class matter under the
 Act of March 3, 1879. All communications
 about subscriptions should be addressed to:
 Circulation Manager, Radio-Craft, 29 Worthing-
 ton St., Springfield 3, Mass.



Notice of CHANGE of ADDRESS should
 reach us at least one month in advance. When
 ordering a change, please furnish an address
 stencil impression from a recent wrapper if
 you can. Address changes cannot be made
 without the old address as well as the new.



Foreign Agents

London—Atlas Publishing and Distributing
 Co., Ltd., 18 Bride Lane, Fleet St., London,
 E.C. 4.
 Melbourne—McGill's Agency, 179 Elizabeth
 St., Australia.



Text and illustrations of this magazine are
 copyright and must not be reproduced without
 permission of the copyright owners.
 Copyright, 1944, Radercraft Publications, Inc.

Contents

May, 1944

Volume XV, No. 8

Editorial: Radio Weather Control.....by Hugo Gernsback 459
 Radio-Electronics Monthly Review..... 560

ELECTRONICS

"Post-War" Television Now.....by Austin O. Huhn 462
 Electronic Rat Trap..... 463
 Practical Electronics, Part II.....by Fred Shunaman 465
 Russia's Electron Robots.....by Dyson Carter 467
 Industrial Electronics, Part III.....by Raymond F. Yates 468

WAR-TIME RADIO

The Electronic Megaphone (Cover Feature)..... 464
 Canada's Pack Phone.....by Phil Glanzer 470
 Black Light Guards England.....by Kurt Doberer 472
 Radio Controlled Glider Bomb..... 490

TEST INSTRUMENTS

Microvoltmeter for Biological Work..... 471
 "Meterology" for All.....by M. Rosenfeld and A. Howard 479
 Electronic Multi-Checker.....by Carl Fishback 481

CONSTRUCTION

Smaller Packs for Portables.....by R. S. Havenhill 473

SERVICING

Tube Substitutes.....by Jack King 474

SOUND

Audio Distortion.....by Ted Powell 475

RADIO TRAINING

Electronic Diagrams.....by Carl H. Winter 476
 Electronic Circuit Checks, Part IV.....by R. E. Altomare 477
 Rare Tubes and Ohm's Law.....by Lucy T. Brisebois 480

DEPARTMENTS

World-Wide Station List.....Edited by Elmer R. Fuller 482
 New Radio-Electronic Devices..... 484
 Question Box..... 486
 Radio-Electronic Circuits..... 488
 Try This One!..... 491
 Technotes..... 506
 The Mail Bag..... 508
 Book Reviews..... 511

ON THE COVER

The Navy's new Electronic Megaphone appears on our cover this month. Public address systems have been extremely valuable in making orders understood in the heat of battle, during landing operations and at other times when verbal orders would have to be passed slowly from man to man. The transportation problem, disadvantage of standard P.A., is overcome by the Electronic Megaphone.



NEW LETTER CONTEST for SERVICEMEN!

**ELEVEN 1st PRIZE WINNERS IN 5 MONTHS
IN CONTEST No. 1!**

Yes, sir, guys, the hundreds of letters received were so swell that *double* first prize winners had to be awarded each of the first four months and there were *triple* first prize winners the fifth and last month . . .

SO — HERE WE GO AGAIN!

Get in on this NEW letter contest—write and tell us your *first hand* experiences with *all* types of Radio Communications equipment built by Hallicrafters including the famous SCR-299!

RULES FOR THE CONTEST

Hallicrafters will give \$100.00 for the best letter received during each of the five months of April, May, June, July and August. (Deadline: Your letter must be received by midnight, the last day of each month.)

For every serious letter received Hallicrafters will send \$1.00 so even if you do not win a big prize your time will not be in vain.

Your letter will become the property of Hallicrafters and they will have the right to reproduce it in a Hallicrafters advertisement. Write as many letters as you wish. V-mail letters will do.

Military regulations prohibit the publication of winners' names and photos at present . . . monthly winners will be notified immediately upon judging.

BUY MORE BONDS!



hallicrafters RADIO

THE HALLICRAFTERS CO. MANUFACTURERS OF RADIO AND ELECTRONIC EQUIPMENT, CHICAGO 16, U. S. A.



and the message *DOES* get through!

One of the first pieces of equipment landed on a newly established beachhead is the Army's high powered, mobile SCR-299. In half-track or truck, this Hallicrafters-built GIANT OF MILITARY RADIO is a vital link in the chain of communications. Subject to the bombing and shelling of the enemy, the sturdy SCR-299 can really take it—and dishes it out by getting the message through to direct the fire of land, sea and air forces.

BUY MORE BONDS!



hallicrafters RADIO

THE HALLICRAFTERS COMPANY, MANUFACTURERS OF RADIO AND ELECTRONIC EQUIPMENT, CHICAGO 16, U. S. A.

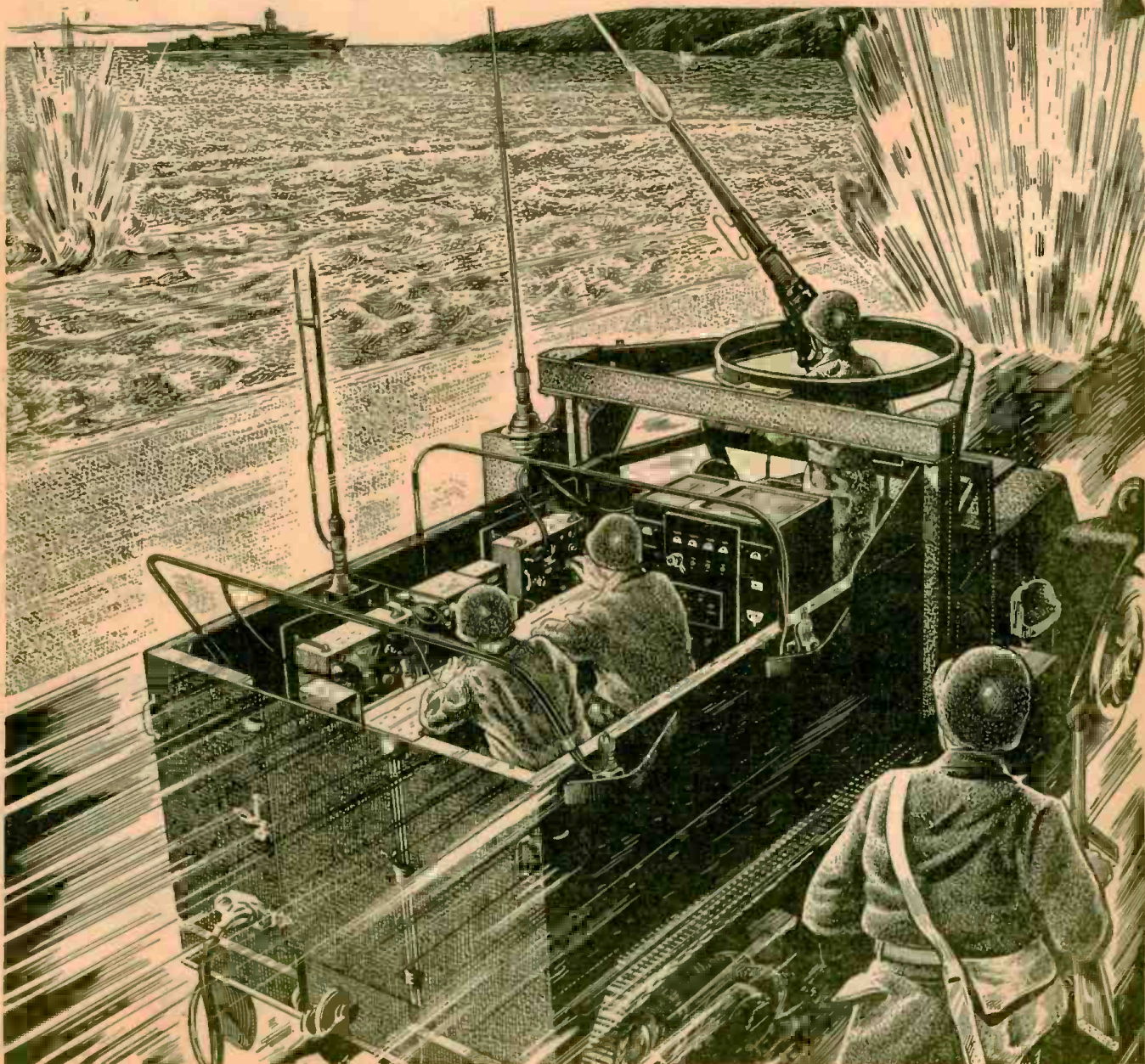

HERE IS YOUR SUCCESS CHANCE

BE A

RADIO-ELECTRONIC TECHNICIAN!

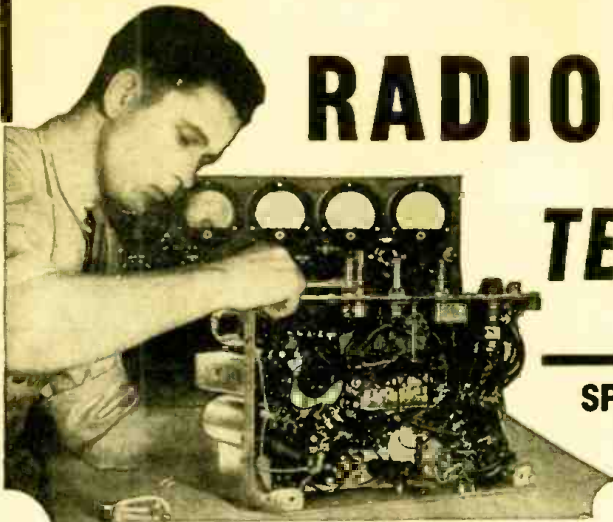

**SPRAYBERRY TRAINS YOU
QUICKLY FOR WAR
AND PEACETIME WORK**

**IF YOU REMAIN A
CIVILIAN OR ENTER
MILITARY SERVICE . . .
Radio Training Will
Enhance Your Future!
• READ THESE LETTERS •**

One Job Nets About \$26.00

"Since last week I fixed 7 radios, all good-paying jobs and right now I am working on an amplifier system. This job alone will net me about \$26.00. As long as my work keeps coming in this way, I have only one word to say and that is 'Thanks to my Sprayberry training' and I am not afraid to boast about it."—ADRIEN BENJAMIN, North Grosvenordale, Conn.

**Sprayberry Graduate Wins
Out in Army Test**

"Since I completed your elegant Course in Radio I have been drafted into the Army and out into the Signal Corps. I had to compete to get the job I now hold and as a result of my training with you, I made the best grade and got the job. The point I am driving at is if it hadn't been for your thorough course in Radio I would probably be peeling potatoes now. I recommend your training to all because it is written in language that the average layman can understand."—ARCI PLUMMER, JR., Fort Meade, Md.

**Student Makes \$15.00 to \$20.00
A Week in Spare Time**

"After starting your Course I began doing minor radio service jobs and I want to say that I have been flooded with work. So much so that I have had to neglect my lessons. I want to say your training has done a great deal for me. I am making \$15.00 to \$20.00 a week in spare time. Even so, I'm going to go back to my studies and finish the Course."—LAWRENCE J. CHILCOINE, Whitley, Ontario, Canada.

**You Do Practice-Giving Experiments
with Real Equipment**

The offer I make you here is the opportunity of a lifetime. It's your big chance to get ready for a wonderful future in the swiftly expanding field of Radio-Electronics INCLUDING Radio, Television, Frequency Modulation, and Industrial Electronics. Be wise! NOW is the time to start. No previous experience is necessary. The Sprayberry course is short, intensive, and interesting. It starts right at the beginning of Radio. You can't get lost. It gets the various subjects across in such a clear, simple way that you understand and remember.

You Get a Dual-Purpose Radio Set

FULL RADIO SET

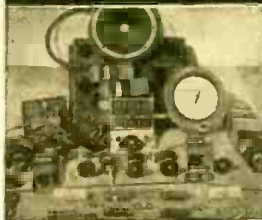

I supply you with Radio Parts which you use to gain pre-experience in Repair work. These same Parts are used for testing and for Signal Tracing, etc. I make it easy for you to learn Radio Set Repair and Installation Work . . . by practical, proved, time tested methods. I teach you how to install and repair Electronic Equipment. Your success is my full responsibility.

**Prepares You for a Business of Your Own . . . or
Good Radio Jobs**

My training will give you the broad fundamental principles so necessary as a background no matter what branch of Radio you wish to specialize in. Soon you'll be qualified for a good paying job in one of the nation's Radio plants doing war work OR a business of your own. If you enter the Army, Navy, or Marines, my training will help you win higher rating and better pay. Let me prove what Sprayberry training can do for you.

EASY TO START . . .

Remember it is not necessary for a Sprayberry student to have any previous experience in the field of Radio. You can master the Course in your spare time. It will not interfere in any way with your present duties.

Along with your Training, you will receive my famous Business Builders which can bring you in a nice profit shortly after you begin my course.



**DON'T
PUT
IT OFF!**

GET FREE BOOK

Get the facts about my training—now! Take the first important step toward the money-making future of your dreams. All features are fully explained in my big, illustrated free book. Write for it at once.

SPRAYBERRY ACADEMY OF RADIO

F. L. Sprayberry, Pres.
Box 500 TE
Pueblo, Colorado.

Please rush my FREE copy of "HOW TO MAKE MONEY IN RADIO, ELECTRONICS and TELEVISION."

Name Age

Address

City State

Tear off this coupon, mail in envelope or paste on penny postcard.

NOW! BECOME A MONEY-MAKING RADIO SPECIALIST

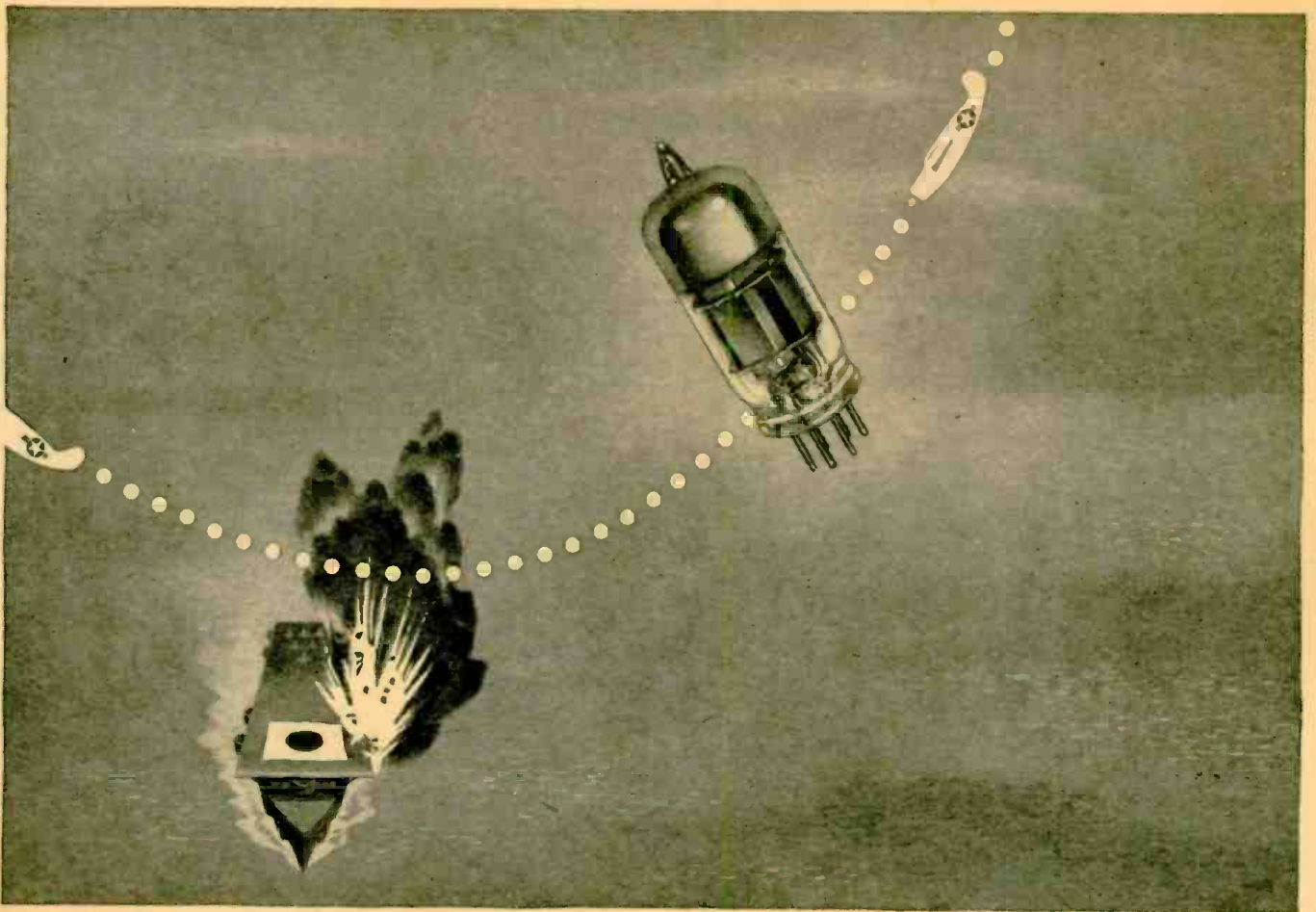

They know their G's

What is this menace to flying men and their equipment which our scientists call "G's"? And why are N. U. engineers who design tubes for airborne radio and electronic devices taking so much pains these days, to *know* their "G's"?

In a mild form, most of us have felt "G's" at work on a roller-coaster, when we take the turns and hit the dips. However, in high speed flight, with its shifting, twisting, turning, about-face maneuvers—"G's" *really* shake your insides. Think of a dive bomber pilot as he pulls out of a high vertical power dive. That's when

"G's" can become dangerously high. And when there are *too many* "G's"—look out!

Research into the effects of "G's" on the delicate, indeed flimsy filaments and other parts of tubes, has enabled N. U. engineers to provide our armed forces with tubes individually tested to withstand many more "G's" than a pilot or a plane ever has survived. For such battle-tested N. U. Tubes there will be many post-war uses, with profit opportunities for service engineers. *Count on* National Union.

NATIONAL UNION RADIO CORPORATION, NEWARK, N. J.
Factories: Newark and Maplewood, N. J., Lansdale and Robeson, Pa.



NATIONAL UNION

RADIO AND ELECTRONIC TUBES

Transmitting, Cathode Ray, Receiving, Special Purpose Tubes • Condensers • Volume Controls • Photo Electric Cells • Panel Lamps • Flashlight Bulbs

ENVY OF AN INDUSTRY...

MEISSNER'S FAMED "PRECISION-EL"



Men of Long Experience: You don't have to be much of a judge of character to know that here's a man who knows his job from A to Z, takes pride in his work. He's typical of the "precision-el" who turn out Meissner's famous line of "Precision-Built" electronics products.



The Meissner "Know How" has long been envied by many in all phases of the electronics industry. There are said to be more electronics technicians per thousand population in Mt. Carmel than in any other American city.



Mighty Unit of America's Might: As far as the camera's eye can reach, it seems, are row upon row of skilled workers engaged in producing vital electronics material for Uncle Sam. This is one unit of the main Meissner plant at Mt. Carmel, Illinois.



Four of a Kind: From miles around Mt. Carmel, entire families have turned to electronics for a place in Meissner's great postwar plans. This family group of four employes, combining many years of varied experience, is about to report at one of the big gates.



ULTRA COMPACT!

Right — it's Meissner's "mighty midget" — a Cartwheel I. F. Transformer only $1\frac{1}{8}$ " by $1\frac{1}{32}$ " by $1\frac{1}{4}$ " high! The perfect replacement unit for the many sets using odd shapes and locations for their I. F. transformers. Excellent, too, for countless AC-DC or Midget type receivers. It's complete with dual trimmers, with one-piece molded plastic trimmer base. Unshielded. For 456-kc only. Our supplies, of course, are limited.

MEISSNER

MANUFACTURING COMPANY • MT. CARMEL, ILL.

ADVANCED ELECTRONIC RESEARCH AND MANUFACTURE

"HOGARTH SAYS HE CAN'T FEEL
REALLY LOST WHEN HE HAS
HIS ECHOPHONE EC-1 ALONG"

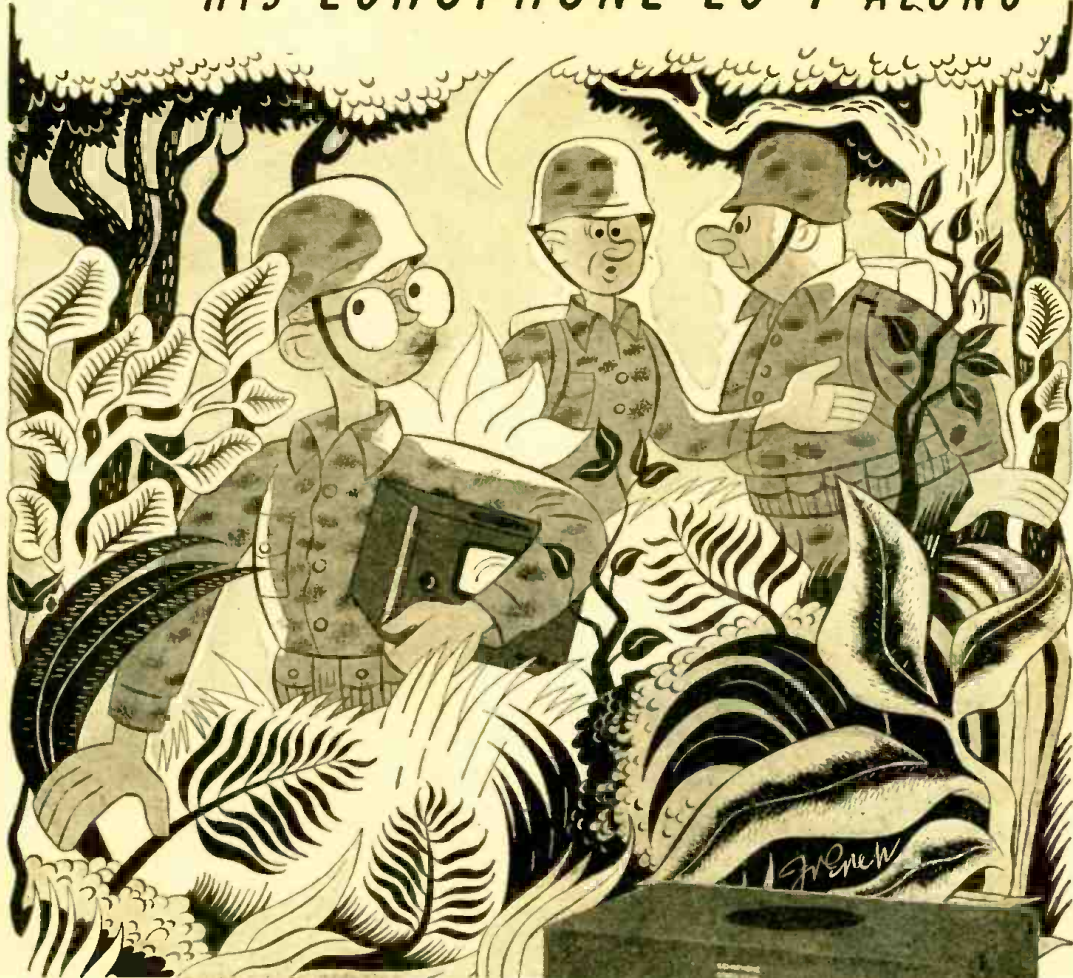

Echophone Model EC-1

(Illustrated) a compact communications receiver with every necessary feature for good reception. Covers from 550 kc. to 30 mc. on three bands. Electrical band-spread on all bands. Beat frequency oscillator. Six tubes. Self-contained speaker. Operates on 115-125 volts AC or DC.



Audels RADIOMANS GUIDE

1001 RADIO FACTS AND FIGURES

772 PAGES · 400 DIAGRAMS · CHARTS AND PHOTOS

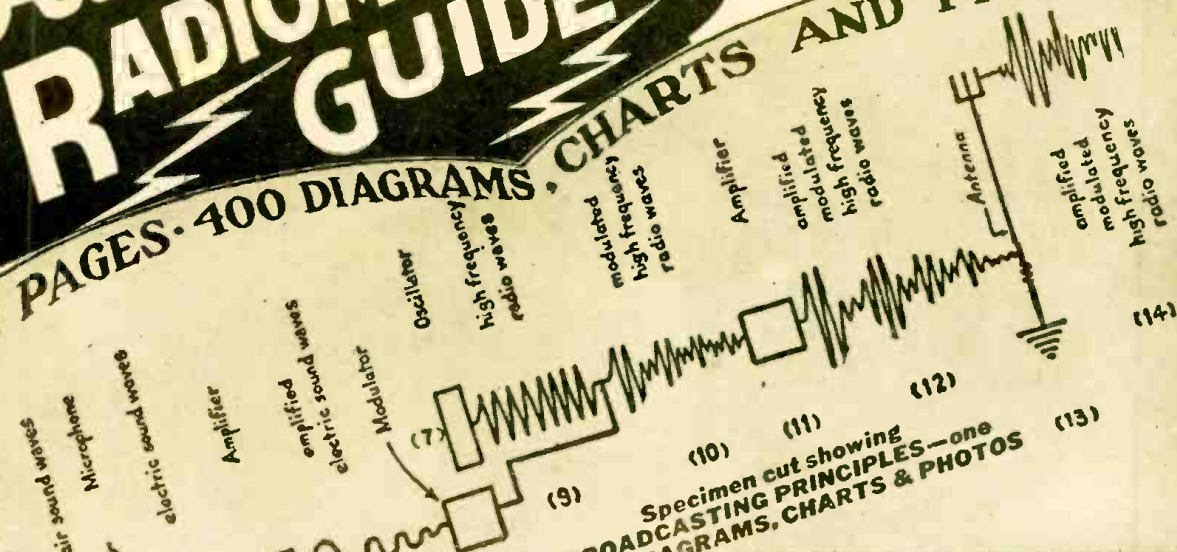

THE KEY TO PRACTICAL RADIO INFORMATION

**Easy to Read — Easy to Grasp
Easy to Apply**

A home-study course—especially well organized. The style is so interesting you will read along without effort, hardly realizing that you are actually studying and taking in vital information. Audels Radiomans Guide gives you just the right amount of mathematics required to cope with radio problems successfully. You can solve, with the aid of this extraordinary book, practically every radioproblem that comes up. At your finger tips is a complete index for instant use.



It gives you in usable form pointers on radio, including frequency modulation, television, etc. Also valuable inside information for Aviators, Marines, Commercial Operators and Technicians, Servicemen and Students.



**Q AND A
UNIQUE
QUESTION
and
ANSWER
METHOD**

Highly Endorsed

A COMPLETE LIBRARY IN ONE BOOK

AUDELS RADIOMANS GUIDE gives authentic Principles and Practices in Construction, Operation, Service and Repairs. Covers clearly and concisely radio fundamentals—Ohm's Law—Physics of sound as related to radio science—Measuring instruments—Power supply—Resistors—Inductors—Condensers—Transformers and examples—Broadcasting stations—Radio Telephony—Receivers—Diagrams—Construction—Control Systems—Loudspeakers—Antennas—AutoRadio—Phonograph Pick-ups—Public Address Systems—Aircraft and Marine Radio—Radio Compass—Beacons—Automatic Radio Alarms—Short Wave—Coil Calculations—Testing—Cathode Ray Oscillographs—Static Eliminations—Trouble Pointers—Underwriter's standards—Units and tables. REVIEW QUESTIONS—READY Reference Index.

7 DAYS' FREE TRIAL

\$4 COMPLETE PAY ONLY **\$1** MO.

THEO. AUDEL & CO., Publishers
49 West 23rd Street, 10, New York

Mail AUDELS NEW RADIOMANS GUIDE for free examination. If O.K. I will send you \$1 in 7 days; then remit \$1 monthly until \$4 is paid. Otherwise I will return it.

Name
Address
Occupation
Reference

MAIL THIS COUPON TODAY

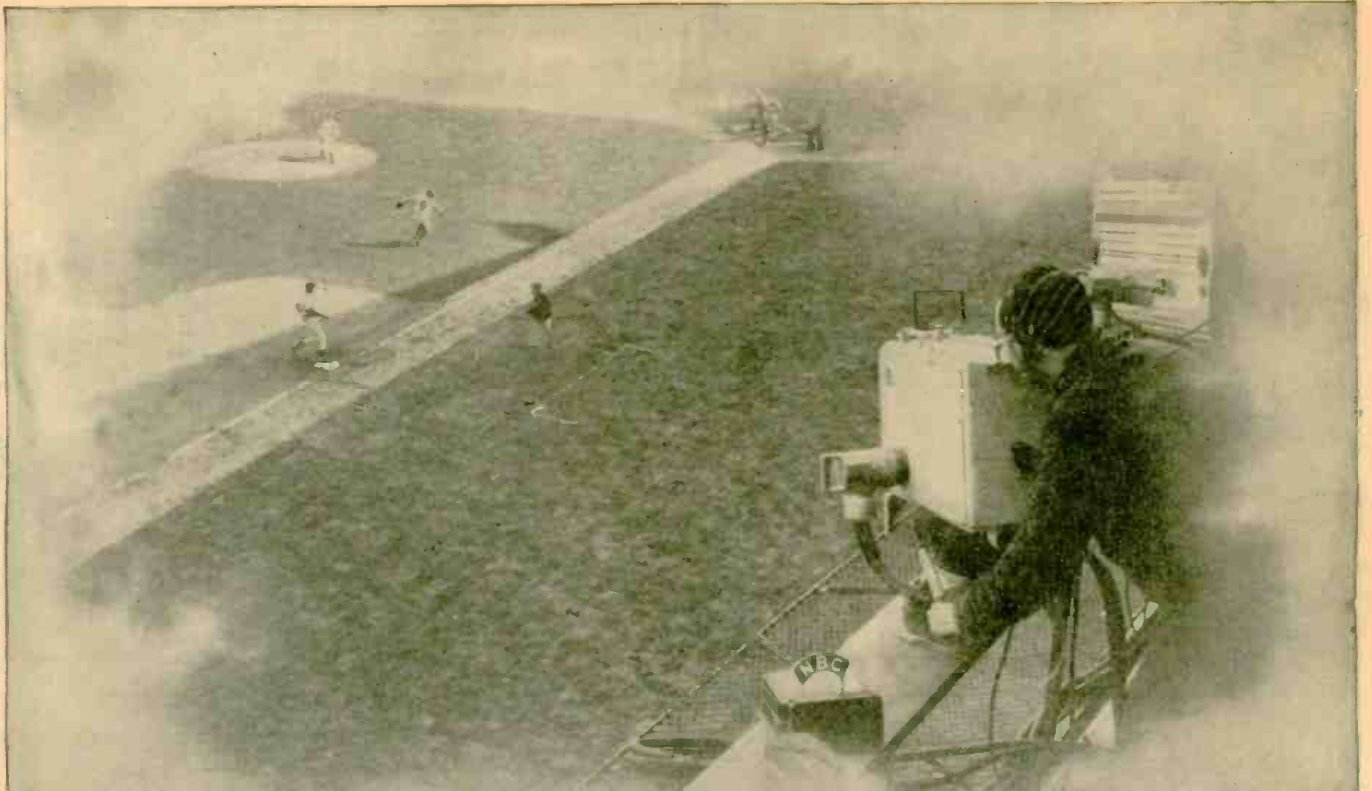

NEW VISIONS for Tomorrow's World

● IT DOESN'T MATTER NOW whether clouds hide the sun, or whether evening shadows fall on the baseball diamond. If the fans in the grandstand see the game so can the modern television camera.

That was not always so; the pre-war television "eye" needed as much sunshine as it could get to illuminate the scene. The same was true of football—final quarters were occasionally "washed out" on the television screen.

But thanks to research, conducted at the RCA Laboratories, a new super-sensitive television camera, rivaling the human eye in its ability to see under

conditions of poor light is in prospect for the post-war world. Then, by television you will see every last-minute play of the ball game as clearly as if you were in the stands. Entertainment, sports, news events will pass before your eyes with every detail, every shadow faithfully reproduced.

Today, RCA's research facilities are devoted to providing the fighting forces of the United Nations with the best radio and electronic equipment available. Tomorrow, these same skills will continue to serve America in developing and creating new and finer peacetime products.



RADIO CORPORATION OF AMERICA
RCA LABORATORIES • PRINCETON • NEW JERSEY

RCA
leads the way in
radio—television—
electronics



TUNE IN! RCA's great new show, 7:30-8:00 P.M. EWT, over the Blue Network, every Saturday ★ BUY WAR BONDS EVERY PAY DAY ★

Radio Weather Control

. . . . In view of the great importance of weather to humanity, it is high time that something be done to control it. Electronic means may in the future supply us with the kind of weather we need and desire

HUGO GERNSBACK

THE old cliché of Mark Twain's weather, about which people talk but do nothing, is still to the point, but it becomes less true every year. There will come a time in the not too distant future when man will be enabled to have the kind of weather he needs.

Fifty years ago this pronouncement might have seemed preposterous in the extreme; today it comes within the realms of possibility and each passing year brings us closer to the goal.

Let us first look at the facts as they are in reality. If you compare the earth to a fair-sized orange, wrapped in tissue paper—not too tightly—then the tissue paper represents the thickness of the zone in which weather of every sort occurs. Indeed, the entire earth's atmosphere way up into the stratosphere, on our orange globe scale would be less than one-eighth of an inch. Few people realize that most of the earth's atmosphere is but a thin film and that 90% of the air that we breathe and in which we live, extends only about 50,000 feet up. Compare this with the diameter of 8,000 miles of the entire earth and you will appreciate how really thin is our terrestrial atmosphere.

Without wishing to go into an encyclopedic discussion of all the factors that make weather, the most important ones are: the radiant heat supplied by the sun, the rotation of the earth on its axis, and the cooling of the atmosphere during night-time, when the sun no longer supplies any heat to it. These and several other factors, coupled with geographical conditions, mountain ranges, latitude, etc., make our weather.

Dr. Charles Greeley Abbot, Secretary of the Smithsonian Institute, over many years of study recently solved one of the most important meteorologic problems of the age. It is now possible—due to his researches—to forecast long-range weather conditions all over the world. These forecasts range from a few days to years; and, what is more important, the forecasts are exceedingly accurate. Dr. Abbot bases his amazing ability to forecast weather at long range on the constant variations of solar heat which the earth receives. The supply of radiant heat which we get from the sun is variable, due mostly to sun spot activity—yet the solar heat

supply as received on this planet varies as much as 5%. There are also other factors, such as volcanoes which throw out fine dust into the upper reaches of our atmosphere, which at times screens out several percent of the received solar heat. When such a volcanic outburst occurs, the long-range forecasts become affected and must be revised.

But how can we actually control weather on earth? The problem is facilitated by what I have said above, in that all weather clouds which bring us rain, hail or snow are only a few thousand feet up, seldom reaching a height of 10,000 feet. For this reason, the problem becomes much simplified.

There have been some instances where weather has been actually affected by man over small areas. A number of years ago several inventors found out that if they discharged electrified sand from an airplane, these sand particles would actually cut large swaths through thick layers of clouds. This was due to the electrification of the sand particles, but we could not hope to control weather over even a fair-sized area by sending airplanes overhead and showering electrified sand over it. This would be rather impractical.

Another notable instance of a man-made weather change occurred in and over the city of Hamburg, Germany, when this city was fired by the R.A.F. some time ago. The raging fires created a veritable tornado—so much so that in some parts of the city it was robbed completely of its oxygen, suffocating parts of the population. This then was a heat effect which for the time being created a man-made storm over a sizable area.

There have also been a number of experiments in electrifying the atmosphere above and around airports in order to free them of fog. These experiments seem to have been theoretically successful, but as they were not made on a sufficiently large scale, so far no practical results have been achieved. It seems certain, however, that fog can be precipitated by electrical means, and this alone would seem to be a worthwhile post-war project.

When it comes to general weather control, it would appear that cities, particularly large ones, want all the sunshine they can get. (Continued on page 492)

Radio Thirty-Five Years Ago

In Gernsback Publications

FROM the May, 1909, issue of MODERN ELECTRICS:

- Signaling to Mars, by H. Gernsback.
- Another Novel Detector.
- Coil Construction, by C. C. Whittaker.
- The Directive Control of Electric Waves, by M. A. Deviny.
- Pivotless Hot Wire Ammeter, by A. M. Curtis.
- Hints for the Wireless Experimenter, by A. C. Austin, Jr.

HUGO GERNSBACK	
Founder	
Modern Electrics	1908
Electrical Experimenter	1913
Radio News	1919
Science & Invention	1920
Radio-Craft	1929
Short-Wave Craft	1930
Wireless Association of America	1908

A Potentiometer for Wireless Telegraphy, by S. Fulton Kerr.
Of interest in the advertising section we

find the following new radio apparatus not made heretofore:

The "Electro"-Lytic Bare Point Detector (low-priced amateur detector), manufactured by E. I. Company, New York.

Also a new Electrolytic Interrupter (for transmitters), the first one of its type for amateurs, manufactured by E. I. Company.

New transmitting apparatus featuring a ¼ kw. set, as well as an essential transformer manufactured by Clapp-Eastham Co.

AERIAL transmitters dropping from the clouds over occupied territory were featured on the March cover of *Radio-Craft*. Last month a Stockholm dispatch carried news of just such a transmitter being put into use.

This special transmitter, says the Swedish source, is presumably suspended from a small balloon, and is released over the target by a fast reconnaissance plane. It then emits a steady signal, which guides the coming bombers.

The pilot transmitter should be of great value, as in many instances the slower bombers would be at a disadvantage in trying to find the target themselves, while exposed to heavy ack-ack. It also gives them an opportunity to take advantage of clouds or mist ceilings on their way in.

LONG-DISTANCE telephony by ultra-short wave will be realized shortly after the war, according to American Telephone and Telegraph Company. Plans for the trial of this new type of inter-city communications facility were announced last month. The work will take at least two years to complete and will cost more than \$2,000,000. It will supplement present commercial long distance telephone facilities and provide network facilities for the transmission of television programs between New York, Boston and intermediate points.

Application is being made to the Federal Communications Commission for approval to begin the project, which is expected to proceed as rapidly as the war situation permits. At present engineers of Bell Telephone Laboratories essential to technical phases of the undertaking are engaged in war work.

The new system will be operated by radio relays of a type which was under development by the Bell Telephone Laboratories prior to the war. This system applies to communication by radio many of the techniques which have played an important part in the development of long distance wire telephone circuits. Directed radio beams at ultra-high frequencies will operate simultaneously in both directions and these will be relayed at stations spaced at an average of about 30 miles throughout the route. It is hoped that, ultimately, each radio beam will carry a large number of communications channels.

This is the first plan for a system of

Radio-Electronics

Items Interesting

this type to handle regular commercial long distance telephone messages over land within the United States and it is believed that it will be the first to handle commercial communications services anywhere in the world.

This project represents another step in the march of radio telephony to utilize shorter and shorter wave lengths. Overseas commercial radio telephony to England was initiated by the Bell System in 1927 using very long waves. Soon afterward "short waves" were developed for transoceanic telephony and today, were it not for the war, it would be possible to talk from any telephone in the United States to more than 70 foreign countries and to any of more than 95% of all the telephones in the world.

Using still shorter waves, only two or three meters long, which do not travel much beyond the horizon, radiotelephone service was established just before the war across Chesapeake Bay between Norfolk and Cape Charles, across Massachusetts Bay between Boston and Provincetown, and between the mainland and Smith and Tangier Islands in Chesapeake Bay.

The new project proposes to use microwaves shorter than any which have heretofore been used for commercial telephony.

The principal purpose of the trial is to determine by practical operation in commercial service the relative advantages and disadvantages of radio relay in transmission of long-distance messages and television programs compared with transmission by the familiar wires and cables and recently developed coaxial cables. Relative costs represent only one of the factors to be determined; others include the relative quality of transmission, flexibility under actual operating conditions and dependability.

AUSTRALIAN post-war television plans are now so well advanced that within two or three years after the end of the war it will be possible to link all the major cities of the country with a television network. This is no mean feat, because the main cities of this small continent range from 400 to as much as 1,500 miles apart.

Authority for this prediction is Sir Ernest Fiske, president of Australian Amalgamated Radio, who was interviewed by reporters at San Francisco last month while en route to New York, Montreal and London from his native Australia.

LOUIS BAMBERGER, founder of WOR, one of the pioneer broadcasting stations of the East Coast, died March 11 at the age of 88.

WOR was launched in February, 1922, in a studio constructed on the top floor of the Bamberger department store in Newark, as a 250-watt job. It grew rapidly, first becoming a 500-watt and then steadily increasing power to keep in the forefront of the Atlantic broadcast field.

Both in local service (the station was not commercialized till 1925 or 1926) and in technical achievement, the Bamberger station was famous in the early days. Old-timers will particularly remember the tests known as "Blazing a Trail to the Orient," in which for the first time American broadcast music was directed to, and received in Japan, China and the Philippines. More than one West Coast American experimenter also listened to Paul Whiteman's band on that historic occasion, most of them hearing an Atlantic Coast station for the first time.

RUMORS of illegal Jap transmitters in Hawaii were scotched by FCC chairman J. L. Fly, in testimony given last month before the Lea committee. According to Mr. Fly, stations were set up to efficiently monitor the Hawaiian ether, but no illegal activity was turned up, either by the Commission or other government agencies.

That there were strong rumors of such activity there could be no doubt, admitted Mr. Fly. "Everybody imagined the Japanese had transmitters in their cars and hidden away," he declared. "The FBI, the Army, the Navy and our people were on the job. There was absolutely nothing."

Monitoring of Japanese-language programs over regular stations was begun by the FCC, in July, 1941, and maintained until Pearl Harbor, when enemy-language broadcasts were stopped by voluntary action of the stations formerly transmitting them. In this respect the FCC problems in Hawaii were simpler than on the mainland, where broadcasts in enemy languages continued after war began.

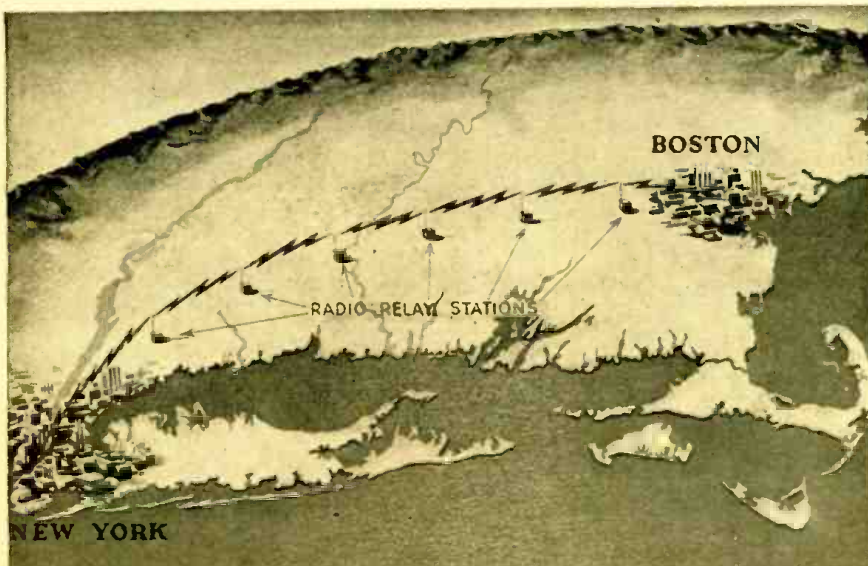

The proposed radio relay line will run from New York to Boston, supplementing existing lines of the A. T. & T., and will also carry experimental television programs for the Boston district.

Monthly Review

to the Technician

HIGH-FREQUENCY radio range receivers are being installed in military and civilian aircraft in preparation for a fundamental improvement in airways marking systems, stated the Civil Aeronautics Administration in a statement issued last month. Transmitters for the new frequencies will be installed shortly, it is expected.

The stations involved are the familiar markers, with the "A" and "N" deviation signals, and the center "beam" which furnishes not only a path for the homing planes, but has supplied the slangsters with a much overworked word.

The present standard equipment sends out signals in the intermediate frequencies—200 to 400 kilocycles. Just before the war the CAA was preparing to change over to equipment using frequencies from 119 to 126 megacycles. The war not only halted that program, but took away from domestic service about one in eight range stations of the standard type. These now are guiding military aircraft over oceans, jungles, deserts, mountains and ice fields.

High-frequency equipment is superior to intermediate-frequency ranges in its ability to send an absolutely clear signal through any kind of weather. High frequency lacks the distance possible with intermediate frequency, but is much more accurate. The high frequency shortcoming in distance will be overcome by increasing the number of ranges.

Removal of the ranges for military use did not affect the safety in domestic airlines, it was stated, because air service to many points was suspended or reduced after Pearl Harbor.

NEW MARKETS for electronic apparatus are to be seen in the greatly expanded post-war aviation field, radio and electrical engineers were told at a joint meeting last month. The speaker, Charles I. Stanton, Administrator of Civil Aeronautics, said that today 60 per cent of the expense of maintaining aircraft is charged to communications apparatus, radio compass and other electronic devices. For contrast, he cited 1932, when only 20 per cent of the maintenance went for radio.

More than 500,000 civil airplanes in the United States in the post-war decade, he estimated, would require to be fitted up with electronic apparatus for safety purpose. The most important piece would be the aircraft radio, on which the flyer must depend for obtaining weather information, without which there can be little safety in widespread private flying.

Required equipment was visualized by Mr. Stanton as a receiver operating on the very high frequencies with direction-finder attachment, and asserted that "at least one company prepared to produce the receiver alone for less than \$30." Many private owners also will want a transmitter, and this, he said, "should not cost more than \$50 on a mass-production basis," according to the Administrator.

NIPPONESE radio propaganda, instead of fulfilling its supposed purpose of breaking down Yankee spirit, actually has been having the opposite effect, and is hailed by the troops as a splendid morale-builder, according to a story in *Radio Daily* last month.

An accurate estimate of enemy propaganda was easy for these soldiers who had the "inside stuff." "The enemy," said one staff-sergeant, "would tell us that ten planes had been shot down on a mission, but we knew that only six had gone out on that raid. Charlie (the Jap announcer) was just about as far off the beam all the time.

"In between sessions of propaganda—which one Nip station always commenced with the theme song, 'It's a Sin to Tell a Lie,' they gave us plenty of Glenn Miller, Artie Shaw and the rest of the top-notch bands. We used to dial for all the jive we could get. We loved it."

Similar stories were told by soldiers on the African and Italian fronts, who report that German broadcasters showed even less solicitude for American tastes in music, and a grosser misunderstanding of Yankee psychology. The most interesting angle, one non-com reported, "was the way the Germans tried to make it sound that they wanted to lose all that territory in Russia." "But the prize bit," says the same non-com, "came from the Nazi announcer who broadcast, during floods in the Midwest, 'All the coffee has been destroyed by a flood at Coffeyville, Kansas!'"

ELECTRON MICROSCOPY has been brought one step nearer the day when a small, compact and easily operated unit will be available for widespread use by doctors and research men, according to Dr. C. H. Bachman of General Electric, in introducing the new G-E suitcase microscope at a meeting of the Radio Club of America last month.

The microscope proper weighs 78 pounds. A vacuum pump used with the instrument and also of average suitcase size comprises a second unit. It weighs 55 pounds. Weight of the microscope can be reduced still further when certain light-weight alloys can be

The new "suitcase" electron microscope. Spectators are, left to right: Dr. C. H. Bachman, G.E. electronics specialist; Frank King, Radio Club of America; Igor Bensen, G.E. development engineer, and F. A. Klingenschmidt, President of the Radio Club.

ADVERTISING plugs have become so much a part of the American listener's daily fare that radio without them sounds artificial. So says Major André Baruch, in charge of the American Expeditionary Stations in the North African area, who arrived in the United States on leave last month.

More than one of the boys, he declared, wrote to complain of the unnatural programs, and to suit their tastes, phony advertising has been inserted. Soldiers now hear solemn announcers extolling the wearing quality—and the excellent fit—of GI uniforms, or are told what will happen to them if they don't take their Atabrin. Between these fake spots are announcements of local entertainments, instructions of interest to soldiers in the area, and appeals to invest more money in War Bonds.

The Expeditionary Forces Stations got away from a modest start with one 300-watt transmitter built in an old packing box, to a chain which now consists of eight stations. These are located in Casablanca, Oran, Tunis, Palermo, Naples, Algiers and one mobile unit with the Fifth Army.

The chain also boasts a short-wave unit to reach the boys in tanks and at Army installations equipped with short-wave receiving apparatus.

BATTERY supplies for rural districts will be limited by the capacity of equipment not needed for production of walkie-talkie and similar military equipment for the expanded 1944 electronic program, according to an OWI release last month. Last year saw 3,750,000 batteries produced, as against 3,500,000 in 1940. All but 2% of these, it was stated, went to rural users.

Rumors that production of heavier items, including radios, might possibly be commenced during the year were utterly unfounded. WPB plans called for allotting a certain quantity of steel and labor to the manufacture of electric irons during the year, but it was pointed out that a similar program in regard to such items as radios or refrigerators would take 30 to 40 times the number of workers and great supplies of critical materials.

used to replace steel and other heavy metals in the instrument.

The unit shown in the photograph below is not a production model and is used for demonstration purposes only. It is ten times more powerful than the best light microscope and operates on 110-volt A.C. power.



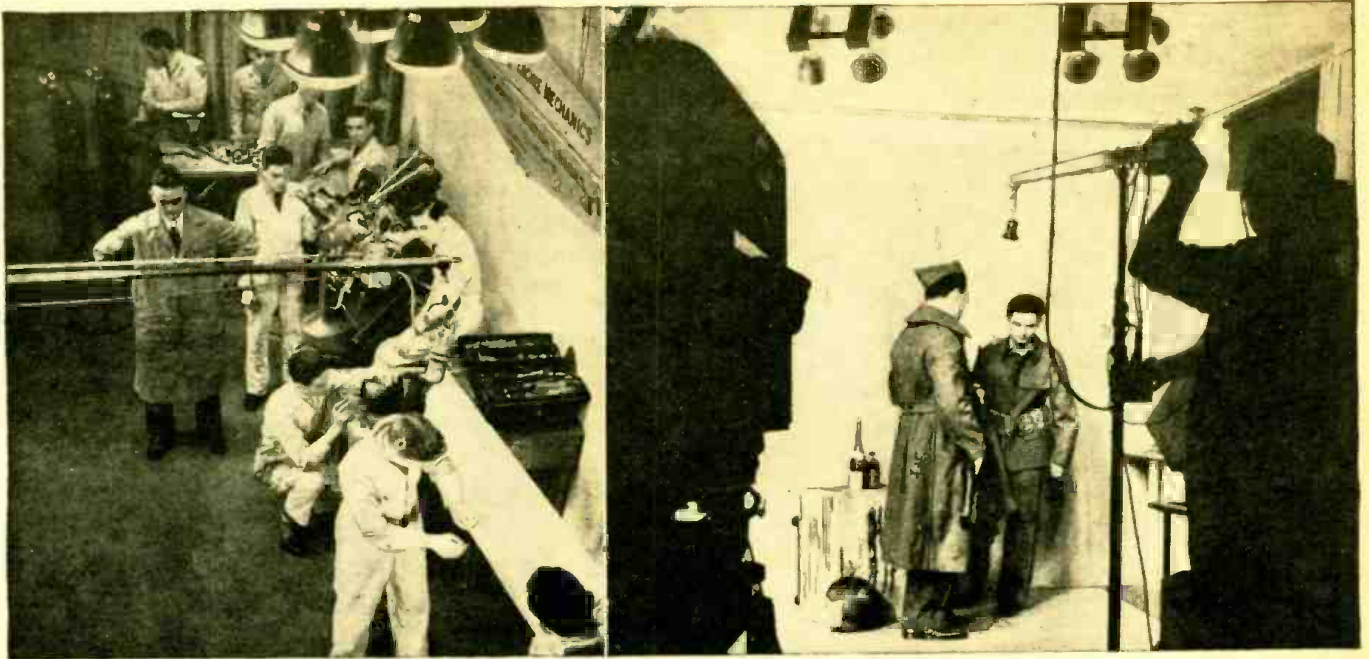

The wide possibilities of television are shown in these two contrasting scenes. One is a presentation of a class in aviation; the other, part of a drama. Note the two cameras.

“Post-War” Television Now

By AUSTIN O. HUHN*

It is ten seconds before “air time.” Camera men are at their cameras. An engineer is ready with the boom mike. Telecasters are ready on “stage one and two” and engineers and directors are in the control room. An engineer on the studio floor receives a “cue” from the control room and signals the announcer to go ahead. Camera one is dollied up to a medium close-up of the announcer. A red light on the front of the camera flashes on, signaling that that particular camera has been switched to the television channel. We’re “on the air!”

Not so long ago, it was said that television could never really go commercial. Networks were impossible due to the characteristics of the high frequencies necessary to carry the video signal. Telephone wires which carry radio broadcasting throughout the country could not carry the television signal and the cost of coaxial cabling to carry the programs was prohibitive. The cost of television program production would run between two and four times that of current radio programs, with the result that it was questionable whether or not commercial television would pay. To telecast a program over an individual station with only the limited coverage and markets that it would offer might cost the sponsor more than he would care to pay, the experts said.

Now, we find that these problems have been taken care of to a great extent. Ultra-high frequency television relay stations have solved the problem of creating television networks and, as a matter of fact, are already in operation on a limited scale at the present time!

In order to successfully produce television programs, entirely new techniques as well as new types of program material had to be developed, and so came what is apparently the first independent television program producing unit in the country, Television

*Technical Director, Television Workshop, New York, N. Y.

Workshop. The “Workshop” is a television program laboratory, equipped with boom mike and viewing camera. It must tackle and solve a multitude of problems. These include script work, camera technique; production of titles and other television “props” as well as proper sound balance and coverage. These items must be tried out, perfected and knit together perfectly to make a single telecast fifteen-minute program. Let’s follow through on the development of a typical television show and see what is done.

HOBBIES ON THE AIR

The program is called “The Hobby Hall of Fame” and brings persons with telegenic hobbies from far and wide to appear on the program. Hobbyists were interviewed and scripts prepared accordingly for everything from a school-girl whose hobby is ventriloquism to a man who has made a complete reproduction of the ships of the U. S. Navy in miniature.

Telecast every Wednesday over DuMont Station W2XWV, “The Hobby Hall of Fame” proved to be successful. A new, original note was introduced with the appearance of “Presto,” a puppet, in the telecast. Presto, attired as an East Indian Fakir, performs feats of magic before the camera to animate commercial announcements and demonstrations, his character tying in with the magic-like characteristics of the product. In designing Presto, the characteristics of the television camera had to be observed. In fact, when working with color at all, in order to obtain desired contrasts, it proved best to work in tones of gray, keeping between something less than a dead black and a dead white. Black, of course, means zero signal from the iconoscope while white is maximum, neither extreme in excess being desirable for a clear, well-balanced picture. Presto, by the way, ap-

pears to be the first puppet to be created specifically for a television program. Let’s see how this miniature magician takes part in the telecast . . .

Camera one swings around on its noiseless wheels so as to be ready for a close-up of Presto. The light flashes red and we steal a look into the viewing scope on the camera in time to see the puppet spring into action. Incidentally, the mike engineer has swung his boom from the announcer to catch what the marionette’s manipulator has to say. The magician waves his wand and with the aid of a little camera “magic” makes the announcer disappear from the viewer’s screen.

TELEVISION’S MAGIC CARPET

Another feat of electronic magic brings a miniature carpet flying into the picture. Presto steps on the carpet, it takes off, and we find ourselves in the home of the Smith’s (accomplished by fading out camera one and fading in camera two which has been focused on the living-room scene). The puppet appears in this scene with his magic carpet, to come to the aid of Mrs. Smith with his sponsor’s product. He produces a package of mending tape which Mrs. Smith finds works “like magic.” The camera fades this scene as the other one now picks up the announced again and the program continues. Presto, his magic carpet, his appearing packages and other feats are all done with hidden strings, supplemented by camera tricks.

No doubt the reader will come to the conclusion from the foregoing that the production of a television program is a complex matter requiring exact coordination of staff and equipment. In this, he will be correct. The production of a radio broadcast is a very simple matter when compared with the production of a telecast program. Secondly, the amount of time required in preparation and rehearsal is much greater

(Continued on page 497)

Electronic Rat Trap

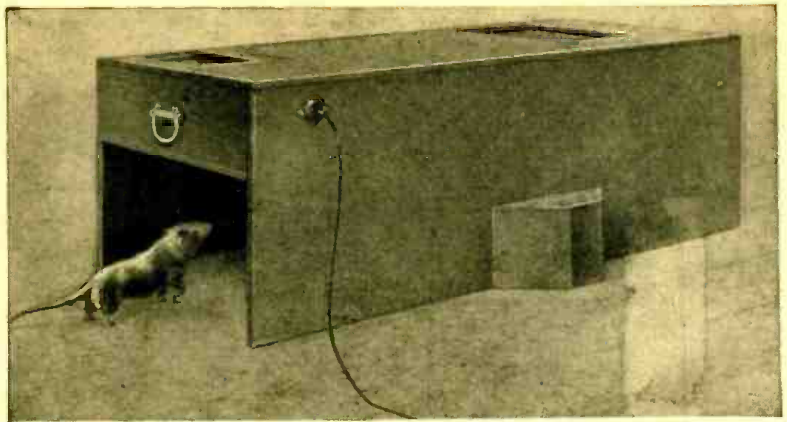

Courtesy Rochester Automatic Trap Co.

ABOUT five years ago, two Rochester electrical engineers were approached by the manager of a large concern who had unsuccessfully tried all the conventional ways to exterminate rats. "You fellows are electrical engineers," he said, "can't you find a way to electrocute rats?"

It sounded easy. The engineers, William J. Vincent and Cornelius M. Stanton, accepted the challenge. But they had not reckoned with the uncanny wisdom of the rat. It soon became obvious to them that they were dealing with a foe whose keen wit was a match for their own.

Today, their half-decade of study and experimentation, during which some 20,000 rats have been destroyed in the experiments, has borne results. What started as a short-time job developed into a fascinating hobby. The inventors finally perfected and patented an electronic automatic rat trap that bids fair to substantially free the nation of the most repulsive, dangerous, costly animal pest that desecrates the earth.

The two Rochester inventors have unconsciously but practically, become naturalists, as far as the class Mammalia, order Rodentia, genus *Rattus* and species *Norvegicus* is concerned. They have watched rats climb iron pipes, looked on as they navigated precariously swinging wires. They have seen them fight each other to the death when caught but not killed in other kinds

of traps. They have seen them put cats and dogs—supposed to be excellent "ratters"—into full retreat. They have seen rats walk on their hind legs, bearing between their forepaws stolen hen's eggs—seen them walk along wires, thus encumbered.

In one warehouse where hams were hung several feet off the floor a great mystery developed when it was discovered that the meat was being gnawed by rats. After nights of watching, Vincent and Stanton actually saw the rats make a pyramid of their own bodies to reach the hams, then take turns "on top" with almost military precision and discipline!

One by one, old-time methods of destruction were tried and cast aside. One by one, features that forewarned or startled the rats were eliminated. Night after night, Messrs. Vincent and Stanton kept lonely vigil in warehouses, factories, hotel basements, etc., watching the wily rodent set their efforts at naught. Gradually, step by step, the veritable Emersonian dream of a rat trap, evolved! But it had taken well over 200 changes of design to produce the first completely satisfactory model!

Since the device uses an amplifier as well as a photo-cell, it may be called a two-tube

receiver—the first rodent receiver on the market! An alternative arrangement proposed by the inventors uses a capacity-actuated relay to sense the presence of the rat in the passageway.

The Rochester Automatic Trap is, in outward appearance, a wooden tunnel, measuring 48 inches long, 21 inches wide and 15 inches high. It has no floor. The inventors found that if the surface upon which the rat is moving does not change he feels more secured in advancing forward. It is open at both ends because the rat is more willing to advance when he can see what lies ahead of him. He doesn't like "dead-end streets."

Midway along the side of the tunnel an infra-red (invisible) beam of light shines across the passageway to a photo-electric cell (electric eye). When the rat cuts across this beam, the circuit is broken and immediately trap doors drop down at both ends of the tunnel—and he is captured!

Now comes the part that shows how Mr. Vincent and Mr. Stanton have analyzed their problem: The rat is caught to be sure, but he is still hale and hearty. Were death to take place at this point, however, it

(Continued on page 502)

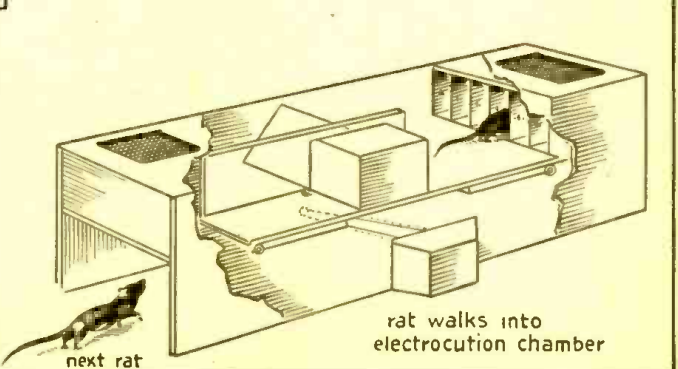
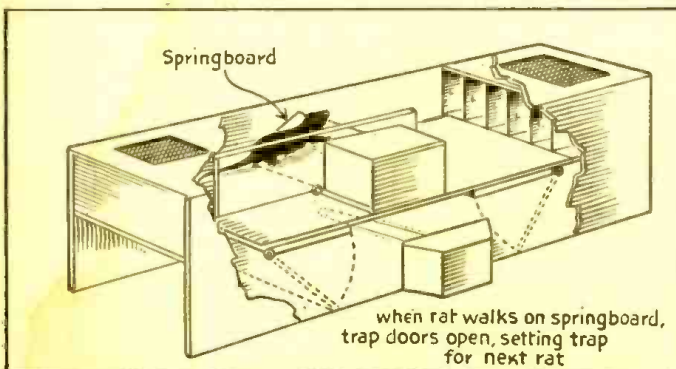
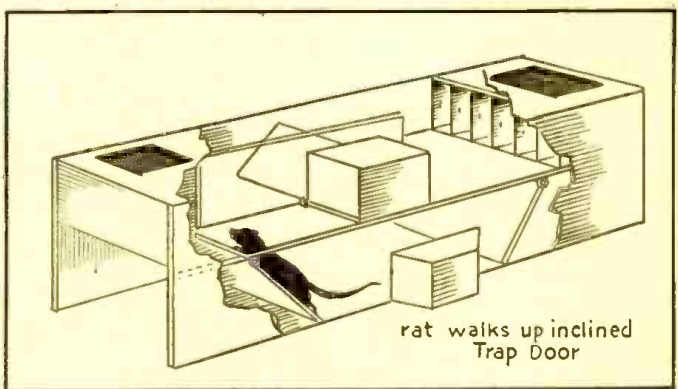
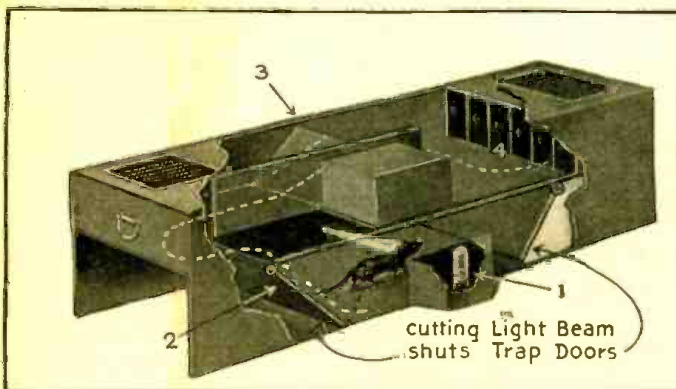

The four stages of the rodent's *via dolorosa*. 1 is the photo-cell. When light to it is broken, the doors drop. 2 is the door which forms a ramp when down. 3 is the spring-door which rises behind him, preventing return, and 4 is the approach to the electrocution chambers.



Courtesy RCA

A close-up view of the present instrument.

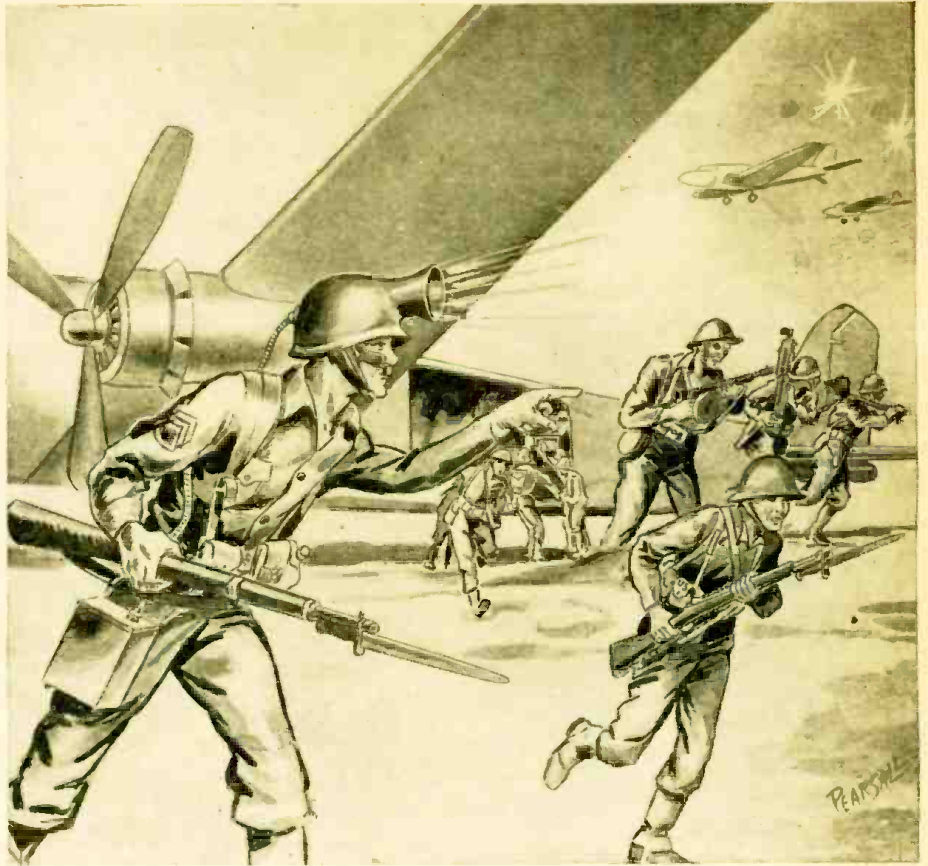

How the electronic megaphone might be adapted to the toughest conditions of combat. By combining the megaphone with the helmet, it is more easily transported and may be turned quickly in any direction. The operator is also able to use both hands.

The Electronic Megaphone

(COVER FEATURE)

Not least of the tasks performed by electronics in this great struggle are those in which old devices have been "streamlined." These non-dramatic applications may have decisive importance.

WAR conditions frequently necessitate the giving of verbal orders to various units of the armed forces so that these orders can be given above the noises ensuing under battle conditions, during landing operations, etc. At advanced front positions, it may also frequently be necessary for various units and individual groups to communicate with each other within the range of the voice, where radio communication would not be advisable.

When airplanes, either fighters or bombers, take off or land, conditions often arise under which it becomes necessary to give orders to the pilots by means of the spoken word and where normal radio communication cannot be made.

Under all such conditions and many others, ordinary megaphones have been used for a long time. Frequently it was not possible for the speaker to make himself understood, as the surrounding noise is often greater than the voice issuing from an ordinary megaphone. For this purpose, the radio-electronic portable megaphone has been devised. A number of different models of these are now being made for our armed forces. Our illustration on the cover, as

well as the illustrations on this page, serve to illustrate the idea graphically.

These megaphones are in use by the United States armed forces at the present time for instructing men on drill grounds, at maneuvers or in landing operations.

One of the recent models is to be seen to the left in the illustration above, which shows the constructional arrangement of the radio-electronic megaphone. It consists of a battery-operated amplifier which is carried by means of straps by the operator. A cable connects the amplifier with a megaphone which has at one end a powerful loud-speaker, and with a specially devised microphone into which the operator talks. This microphone is of such a type that little, if any, extraneous noise is picked up. In this manner the apparatus amplifies only the speaker's words, which issue in stentorian tones from the megaphone.

The outfit has been designed in such a way that the weight is kept down to a minimum, so as not to hamper the operator unduly. When not in use, the megaphone itself hangs in front of the operator from a neck strap, as illustrated in the photograph. The batteries are so chosen that

they will last for a considerable time before renewal is necessary.

A different type of radio-electronic megaphone is shown in the illustration to the right. This construction has been suggested by *Radio-Craft* and is designed to keep the operator's hands free so that he can use a rifle or other equipment if necessary. The idea is fundamentally the same, except that instead of being held in the hand, the megaphone has been combined with a regulation helmet. This helmet carries the megaphone as shown in the illustration. Merely by turning his head in the proper direction, the operator can direct his voice where it will carry best. The helmet is so constructed that inside it there is the usual sound labyrinth, which is necessitated by the shortness of the megaphone construction.

The lip microphone, of the type as described in our January issue, is preferred here because it is small, weighs little, and is not affected by extraneous sounds. In this version of the radio-electronic megaphone, a portable battery amplifier, of the type described above, is used. This combination should have definite advantages, particularly under battle conditions.

PRACTICAL ELECTRONICS

LESSON II—CURRENT, OR ELECTRON FLOW

By FRED SHUNAMAN

EVERY piece of "solid matter" is a small replica of the heavens on a starry night. Its solidity is practically all nothingness, throughout which atoms are spaced, each like a little solar system, with the nucleus taking the place of a sun in the center, and the planetary electrons revolving around it in their various orbits.

The number and orbits of these electrons differ with different kinds of matter. That is why some substances are better conductors than others. The electrons are supposed to be grouped around the nucleus in shells, much like the layers of an onion. No more than two electrons can occupy the first shell, and no more than eight the second. Each shell has its maximum number of electrons, the biggest ones having room for 32. In such an atom as that of sodium, with 11 electrons, there are 2 in the inner shell, 8 in the next and one lone electron circling way out in space, trying to start a third shell on its own.

The bond between such lone electrons and their atoms is weaker than that of the electrons closer to the nucleus. They can therefore be more easily torn loose from it (for example through collision with another flying electron). The parent atom then becomes temporarily a positive ion—an atom looking for an electron to restore its electrical balance. This will not take long. As we have seen in the last lesson, the only force on earth as strong as the repulsion between electrons is the attraction between them and the positive nucleus, without which any small piece of matter would fly apart with a vigor which would make the efforts of TNT look like the action of a damp cigarette lighter.

Because of these tremendous forces of attraction and repulsion, there is always a certain restlessness in such atoms as sodium, copper, silver, zinc or aluminum, which have one or a few electrons in the outer shells. (See figures of sodium and copper atoms in Lesson I last month). Electrons are continually pushing each other out of the outer areas of neighboring atoms, or being drawn with irresistible force toward those which have just lost an electron.

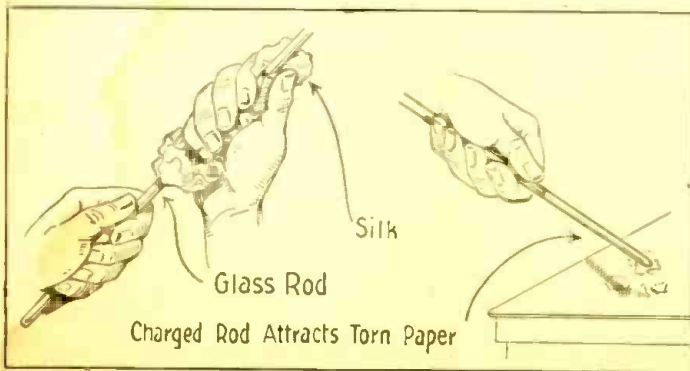
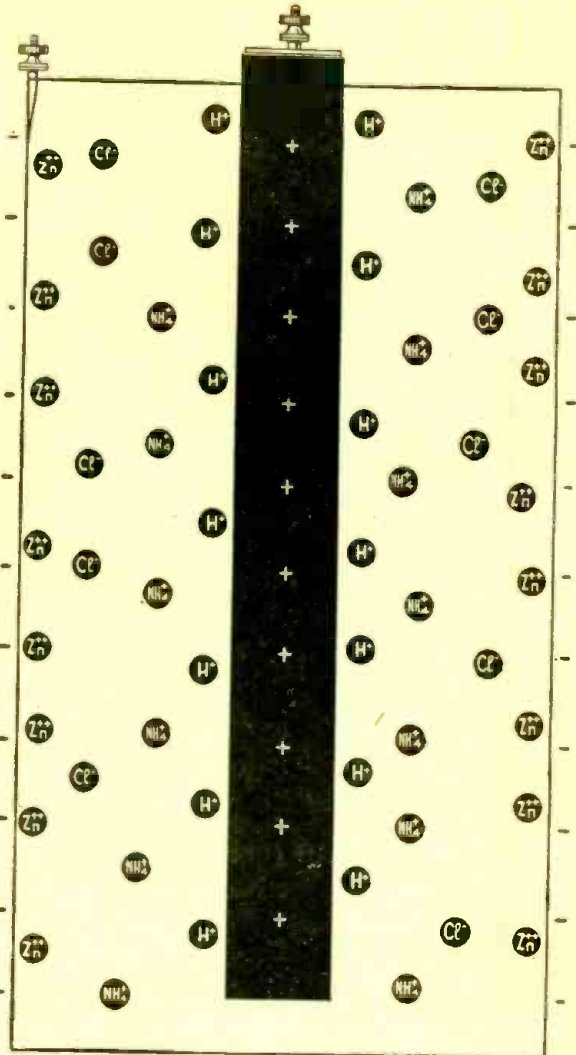

Fig. 1—Charging a glass rod by rubbing it with silk, so that it will pick up small dry bits of paper. This oldest of all electrical experiments was known to the ancient Greeks.

Fig. 2—Slightly simplified view of the chemical action in an ordinary dry cell. The negative ions of chlorine move toward the can to combine with the positive ions of zinc. Hydrogen and ammonium ions drift toward the center, seeking for electrons to restore their primal balanced state.



If we can get all these electrons to drift or travel in one direction along a rod or wire of some conducting substance, we have an electric current. This is easy. All that is necessary is to create a shortage of electrons at one end of the conductor and a surplus at the other. Attraction and repulsion will take care of the rest, and electrons will flow from the surplus toward the shortage.

There are numerous ways to create such "electric pressures." Friction, heat, light or chemical action are a few. We are all familiar with experiments in static electricity, in which charges are produced by rubbing electrons off one substance by another. For example, silk is electrically "harder" than glass, and if a glass rod is rubbed with silk, it will lose electrons, which accumulate on the silk. In its endeavor to get back to its balanced state, the rod will then drag electrons distances which must seem astronomical to such ultra-minute bodies. If these electrons are firmly imbedded in bits of solid matter such as small pieces of paper, the force is strong enough to lift the whole piece along with them. See Fig. 1.

Chemical action in the electric cell, or "battery" is a practical method of separating electrons from their atoms. The common dry cell, used in flashlight and other batteries, is one of the best examples. It is shown in Fig. 2. The dry cell is funda-

mentally a solution of ammonium chloride (sal ammoniac) in a zinc can. A carbon rod, surrounded with a depolarizer, is placed in the center, for electrical reasons, and the can is filled with sawdust, carbon dust, or some other substance to soak up the solution and make it non-spillable.

When many chemicals are dissolved in water, (or other liquids) some of the components lose electrons to the others. A solution of ammonium chloride (1 atom of nitrogen, 4 of hydrogen, and one of chlorine, NH₄Cl) in water breaks down into ammonium ions with a positive charge (NH₄⁺), and negative chlorine ions (Cl⁻). These Cl⁻ ions find it easy to regain their missing electrons and again become atoms by uniting with the zinc of the can to zinc form chloride, (ZnCl₂). The zinc atoms are drawn into solution as "double positive ions" (Zn⁺⁺), each atom leaving two electrons behind it in the can. These "free electrons" left behind by the departing atoms soon build up a negative charge strong enough to prevent any more Cl⁻ ions approaching, and thus stop the action.

Meanwhile the NH₄⁺ ions are repelled by the Zn⁺⁺ ions entering the solution, and move toward the carbon pole at the center. They rob a few electrons from it, giving it a positive charge, and the process comes to a stop here, too.

If we could conduct the electrons from the can to the center pole, the surplus in the zinc would relieve the shortage in the carbon, and action would be continuous till all the zinc in the can was converted into zinc chloride. We all know that this can be done very simply by connecting a wire between the two. If we connect a flashlight (Continued on following page)

(Continued from previous page)

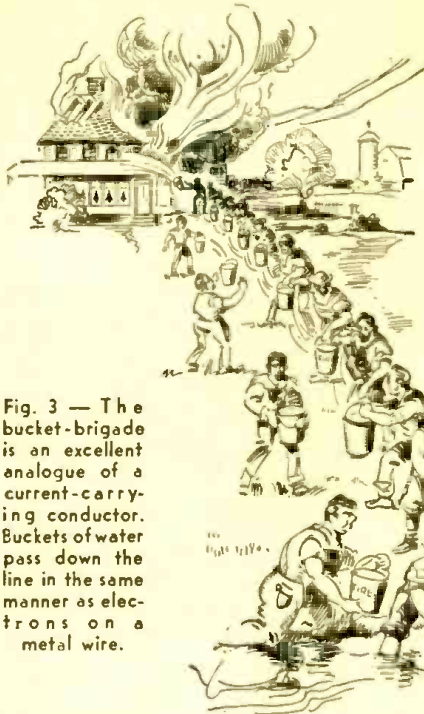

Fig. 3 — The bucket-brigade is an excellent analogue of a current-carrying conductor. Buckets of water pass down the line in the same manner as electrons on a metal wire.

bulb between the two poles, the electrons will still pass, but not so readily. That's another story. Now we want to find out the how and why of conduction.

A flow or drift of electrons along the wire constitutes an *electric current*. It is easy to set up such a drift, because of the remarkable distaste electrons have for each other. As soon as the circuit is complete, some of the surplus electrons on the zinc start crowding into the outer shells of the copper atoms nearest them, repelling the outer electrons of these atoms further down the wire. The electrons at the *negative*, or zinc pole, skip from atom to atom down the wire, and flow into the *positive*, or carbon pole. Chemical action in the battery continually releases electrons in the zinc and brings fresh positive ions up to the carbon, thus keeping up the process as long as there is zinc or solution in the cell.

As anyone who has played with electricity knows, this action takes place much faster than it takes to describe it. It may

not be so apparent that the action is much faster than the speed of travel of the average electron. When electricity is released into a new power line hundreds of miles long, it travels at a speed closely approaching that of light or a radio wave. Lamps at all parts of the circuit light at the same instant. The individual electron, on the other hand, "may bump around in the circuits for a couple of months" before it finds its way back to the generator from which it started.

What happens is illustrated in Fig. 3. This is a bucket brigade, as used in the old-fashioned fire department. Each man in the brigade represents (to us) an atom. The bucket of water he holds is an electron. The stream of course is a plentiful source of this kind of electron, and the fire represents a great shortage of such. Once each man has his bucket full, the dipping of a new bucket at the stream results in the almost immediate delivery of a bucket of water to the fire. Each bucket along this fully charged line has to be displaced to the extent of one person only to transmit (in effect) a bucket of water from the stream to the fire. A wave of motion may be seen running down the line at a speed far greater than a bucket could possibly travel.

A similar wave carries electric current down a conducting wire. It is necessary only that a number of electrons be pushed from their atoms to those directly ahead of them. They in turn displace others which in turn repel those ahead of them, with the final result that numbers of electrons are delivered at the positive end. The process is as simple as the bucket brigade.

To produce any practical results, quite a few electrons must flow. For example, to have a flow of one ampere (very roughly the amount of current that flows through a 100-watt lamp), something like 6,280,000,000,000,000,000 electrons must pass through the lamp every second! If we want to do any useful work with our electrons, we must be able to measure these numbers, and to increase or decrease the flow to a quantity suited for any given job.

Several things affect the electron flow. One of these is the stockpile of electrons at the negative end (and the corresponding

shortage at the other). An increase in this electrical pressure will result in a greater flow. This pressure, as we have been calling it, is known as *electric potential* or *voltage*. The electron arrangement makes some substances better conductors than others. With a given voltage, more current would flow over silver or copper than—for instance—iron or carbon.

The next lesson will discuss the factors controlling electron flow and show how to measure and calculate it.

NOTE

(It will be noted that the direction of electron or current flow has consistently been given as from the negative to the positive end of the circuit, in opposition to common practice of the past. If older readers are puzzled, the answer is simple. The traditional method of describing current flow dates back to Benjamin Franklin, who introduced the terms, "negative" and "positive." He had no way of finding out the actual direction of current flow, and guessed at it. Unfortunately for the electronic age, he guessed wrong, and from that time till a few years ago, current was always spoken of as flowing from positive to negative. With the growing importance of the electron tube, in which we cannot imagine a flow in that direction, we have entered a period of confusion, in which it is necessary for an author to state what he means by current and which way he intends it to go. In this series, current or electron flow will always be from negative to positive.) Of course the current flow which completes the circuit inside the cell may be considered to flow from positive to negative.

TEN-IN-ONE CARRIER

CARRIER current is the means used for making transmission-line conductors carry not only electric power, but also intelligence such as voice, relaying, telemetering, or control signals. The scheme generally employed has been to generate a carrier or radio-frequency signal and superimpose it on the transmission lines. By keying (starting and stopping) this carrier wave on a code basis, various relaying, supervisory, or metering signals can be transmitted one at a time. Or the wave can be modulated by audio waves for voice communication. But obviously, when the carrier wave is interrupted to carry one kind of signals, it cannot be used to perform other chores.

New equipment now makes this possible. A carrier frequency is generated as before, but it is transmitted continuously. It serves as a continuous vehicle for as many as ten independent tones or audio waves, each of which can be used as a channel for a different function. While it is possible to have ten different pieces of intelligence sent simultaneously with other functions, six of the tones must be dropped out to accommodate a frequency band wide enough for satisfactory communication. This still leaves four tones for other functions that continue without interfering with or interference by the conversation.

In addition to this great increase in application flexibility, the new carrier equipment (called the JY) is also arranged for maximum mechanical flexibility. The transmitter and receiver panels, the individual tone panels, and all other auxiliary panels, are standard 19-inch relay rack type, which permits convenient arrangement in many desired combinations. Several sizes of cabinets are available, all of which are equipped with hinged frame on which the various units are mounted.—*Wartime Engineering (Westinghouse)*

Electrigrage, one of the newest of the electronic measuring devices, measures the accuracy of thread gauges, threaded parts, machine-tool lead screws, etc., on a scale graduated in fifty millionths of an inch. Readings can be interpolated down to twelve-millionths of an inch.



Fig. 4—Cut-away view of the dry cell whose internal workings are illustrated in Fig. 2. Construction details differ slightly in different makes of batteries, especially the smaller flashlight types and European cells.

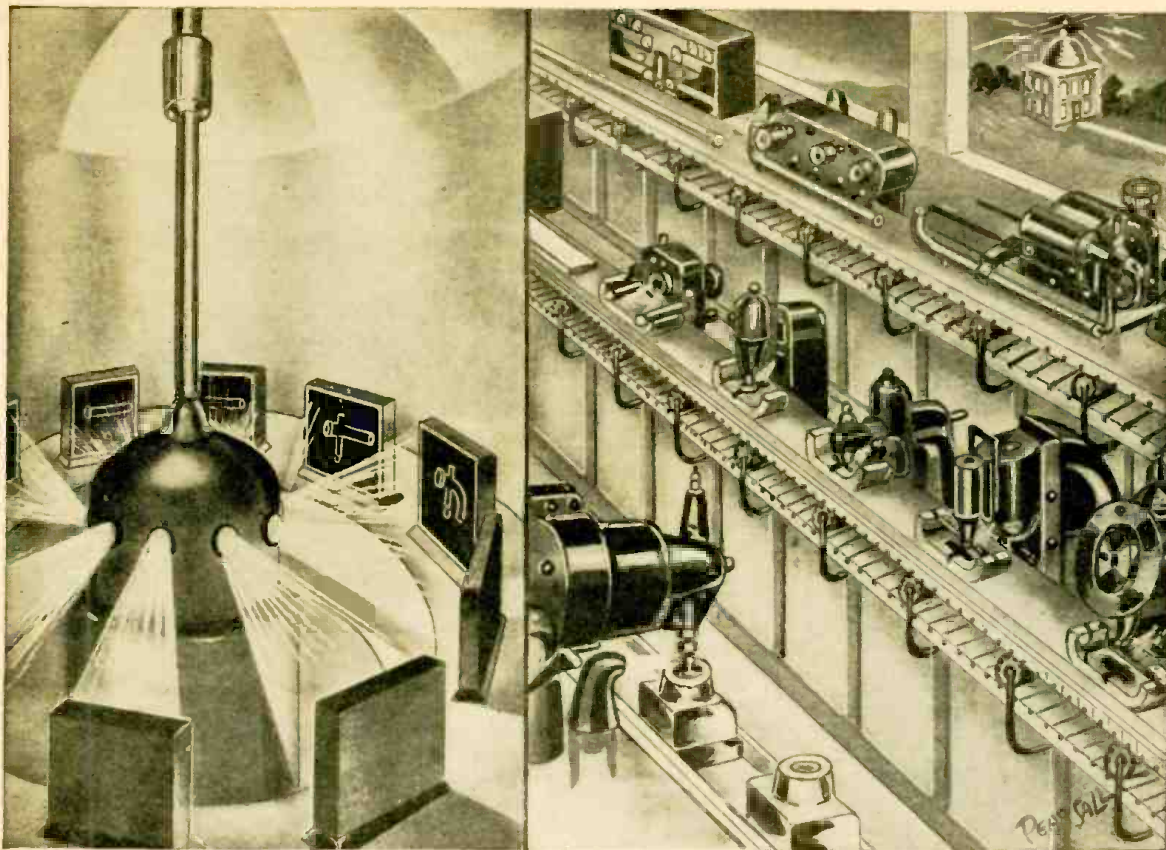

How the Russian electron robot turns out machine parts from the blueprint, as imagined by our artist.

Russia's Electron Robots

By DYSON CARTER

WE have all read about "atom-smashing"—research done to find out what atoms are made of. Now in the Soviet Union smashed atoms are being used, not just for scientific purposes, but in order to smash Hitler. The Russians have mobilized even their atoms, and "atomic shrapnel" from exploded atoms has become one of the remarkable potent weapons backing up the great Red Army offensive.

Perhaps you recall speeches by Hitler and Goebbels that have tried to explain defeat to the German people by protesting that the Russians had brought up overwhelming quantities of tanks, artillery and planes. The Nazi leaders were frank in their amazement. They had not the faintest idea where the Red Army had obtained such vast reserves of equipment. Only a small amount came from America, Canada and Britain. Up to the time of Stalingrad we had been told, and Hitler had believed, the U.S.S.R. had lost a large portion of its production centers and resources in the earlier Nazi drives. But all of a sudden the Red Army hurled forward enormous amounts of new mechanized equipment. Where did this come from? More important, who made it?

Our own production experts tried to answer these questions by saying that the Soviet Government had mobilized every man, woman and child in the huge Republic. Also that many factories had been transferred from conquered areas to safe places in the Ural Mountains. Both these

explanations were in part true. But they omitted one extremely important fact.

It is now possible to reveal that the lavish reserves of heavy equipment poured into the Soviet offensive along a 2,000-mile front have been turned out by absolutely new production methods, including some revolutionary manufacturing techniques. Just as the Red Army's tanks, guns and planes have proved to be superior in quality to those of other nations, so now the quantity of Soviet production exceeds anything previously thought possible. Smashed atoms have played a vital part in this new kind of Soviet mass production.

The secret of the new production technique is the *electron*. Electrons are the shrapnel from atoms that have been blown up. It takes thirty billion, billion, billion electrons to weigh a single ounce. In communication and detection equipment electrons fight for us on all war fronts. Every nation uses electronic devices. America, Britain and Canada have made some progress in putting electrons to work in war plants. But it is in the Soviet Union that these infinitely small particles of matter have taken on superhuman powers.

Before we consider the new factory technique it is interesting to note that Stalin hinted some time before the offensive that surprises in production might be expected. He pointed out that in the first year of war Soviet equipment was superior to the enemy's, but quantity was lacking. He promised that this difficulty would be over-

come, despite the loss or destruction of great production centers. None of our commentators paid any attention to this highly significant hint of Stalin's. But after the great Red Army offensive began, it revealed to the world what miracles of quantity production had been achieved. Then Alexander Shcherbakov, Chief of the Soviet Information Bureau, stated simply: "Of great importance for the country's military might is the work of Soviet scientists in prospecting for new raw materials . . . and in the elaboration of new methods of their utilization." Shcherbakov is Secretary of the Central Committee of the Communist Party in the Soviet Union, and he does not waste words. He was frankly informing the world that Soviet Science had developed *new* methods of mass production. One of those is the electronic production method.

Have you ever seen a "robot," or mechanical man? These are electrical oddities that obey simple instructions when spoken to, such as getting up off a chair, walking, shaking hands. For many years writers have toyed with the idea of robots that could actually think, or, at least, work at manual labor. Now in the Soviet Union a robot machinist is actually at work. This robot has electric wires in place of nerves. Instead of thoughts the robot's brain is buzzing with electrons which have eyes, never make mistakes, never get tired, never even blink. Its eyes stare hour after hour at strange drawings. This weird creature

Continued on page 495

Below—How "a shot for the basket" looks to the eye of the stroboscopic camera. The positions of both player and ball are photographed by successive exposures of extremely short duration, ten exposures every second. At right—High-speed photography combines with the X-ray to give us a new-style action shot. The Westinghouse ultra-high-speed X-rays have stopped all movement and now look through foot and football.

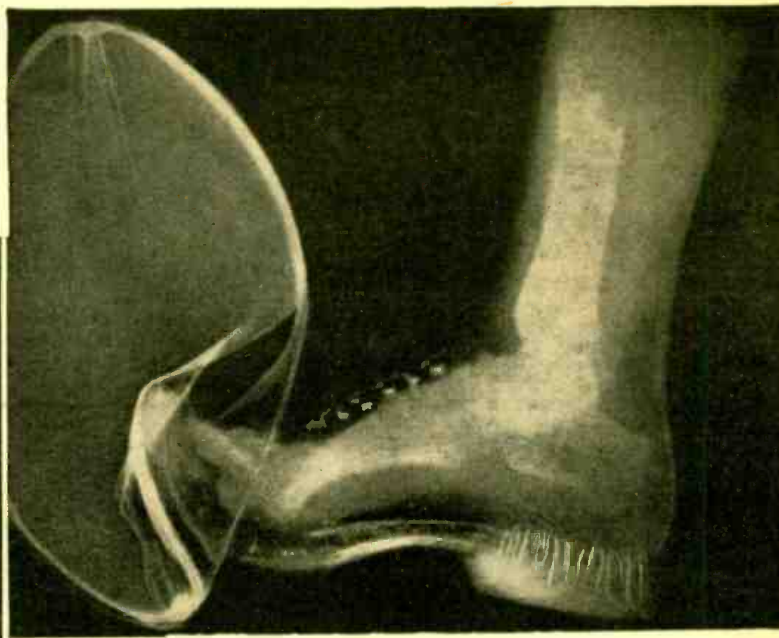
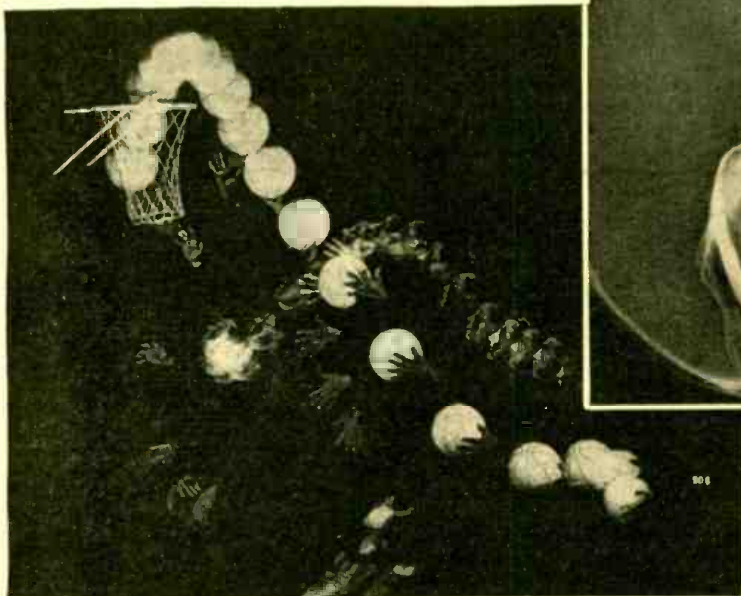

PHOTOGRAPHY AND ELECTRONICS

PART III

By RAYMOND F. YATES

INDUSTRIAL ELECTRONICS

SOME fifty-seven years have passed since Hertz found that light was capable of discharging zinc sheets bearing negative charges. Soon afterward it was found that certain kinds of light, such as ultra-violet or X-rays, had the power to make ordinary air more conductive. When the electrodes of a high voltage spark gap were separated by a distance just beyond the limit that a spark would pass, the presence of ultra-violet light would lower the resistance and the electric discharge would take place. Under these conditions, a lower voltage would cause the spark to jump the gap.

Finally, Prof. J. J. Thomson, discoverer of the electron, proved in 1899 that Hertz's effect was due solely to the emission of electrons under the impact of light. Later Albert Einstein offered a mathematical interpretation of the photoelectrical effect and proved that the power of light to release electrons from metallic surfaces was a function of the frequency of the light; the shorter the light waves the larger the number of electrons released.

It was obvious from this and work that

went on subsequent to that mentioned that the electron had photo properties.

More important still, Sir William Hamilton observed that streams of electrons behaved in a manner similar to beams of light when they were subjected to certain magnetic or electrostatic fields. The "lens" in such cases have to be formed by coils or charged plates, "electron lenses," so-called. Thus came into being the fabulous electron microscope with its power to magnify particles as much as 100,000 times and to photograph such magnifications, the "light" being nothing more or less than a stream of electrons.

We know that ordinary light passing through an ordinary glass lens is bent or "refracted." The same happens to an electron or a stream or beam of electrons—as we shall see by reference to Fig. 2—when the beam passes between two charged plates. The voltage gradient between the plates is indicated in the drawing. We note in Fig. 3 that magnetic forces or fields may also cause electrons to be "refracted" or bent. Thus it will be understood that electrostatic or magnetic fields may be used

either to focus electron beams to a point or to bring about a large degree of divergence.

Thus does the *modus operandi* of the electron microscope become understandable. Fig. 4 shows a very simple diagram of an electron magnifier. At the top we see an electron gun, which is nothing more or less than a hot filament supplying free electrons. The 'scope shown has three lenses. First there is the condensing lens, then the objective lens and finally the image projector lens. The reader can also see where the object to be magnified is placed in the path of the electron beam, just before it enters the objective lens. The passage of electrons through the thin object to be viewed so alters their speed that the impression of the image will be carried along to the second or viewing stage of the instrument where a photographic plate may be placed, or which carries a fluorescent screen.

ELECTRONIC ILLUMINANTS

The electron microscope is neither the beginning nor the end of the story of the

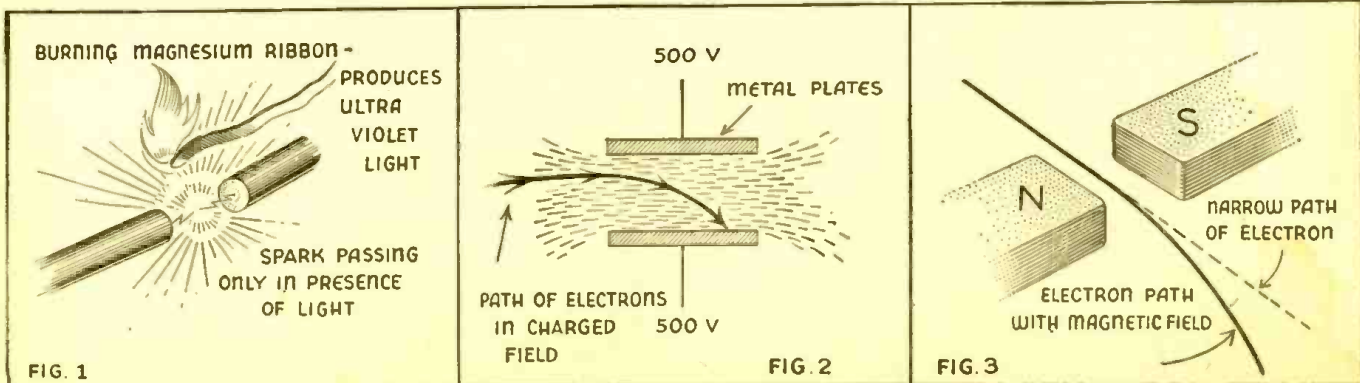

electron and its effect on photography. In the years to come many new things will be developed, especially powerful but sensitive electronic illuminators that will be far superior to any form of illumination used for photography at the present time. We already have a light smaller than our little finger which—although its total life is only a second or two—is capable of supplying illumination for thousands of pictures.

Prof. Harold Edgerton of M.I.T. has perfected an electronic speed lamp, the diagram of which appears in Fig. 5. Edgerton was inspired by early experiments in France, especially those conducted by Prof. Bull, wherein the electric spark was used as illumination for high speed photography. Bull took truly marvelous moving pictures of bees in flight although he had no electronic equipment of any kind as we recognize such equipment today. Bull's scheme will be seen by reference to Fig. 6. No mechanical shutter can be made to function at really high speed, so Bull simply arranged to turn a spark on and off at high speed while a large wooden drum turned with unexposed moving picture film mounted around its periphery. This axis upon which this drum revolved also carried a drum commutator or rotating contacting device that closed the high voltage circuit and permitted the spark to pass at proper intervals.

Edgerton's device is simple enough and is really intended to be ordinary still photography. Even this sort of photography is spectacular. Taken in 1/30,000 of a second, such photographs freeze the motion of a high speed object with unusual results. A stream of water issuing from a faucet appears to be made of glass.

A view of Edgerton's circuit will make it clear that the argon-filled gaseous lamp which produces light with very high actinic value, is set off by the discharge of a small condenser C, the latter discharging through the lamp directly.

Photoelectric control has long since been employed in the commercial production of photographic prints. These tubes automatically time an exposure. Such devices, however, are not easily applied to printing from the negatives used with Kodachrome, where careful color separation negatives must be prepared. The equipment shown in Fig. 7 is employed for this work. The mechanism may be called a densitometer. A small lamp with its beam passing through an opening in a screen causes light to fall on a unit area of film. Densitometer readings are made on the meter in the circuit of the last tube. The use of such equipment greatly simplifies the production of acceptable Kodachrome color positives from colored transparencies.

Clinton D. Veber of Rutgers University has aided a certain kind of photography through the perfection of an electronic timing device which he has called a "time telescope." It was developed primarily for taking moving pictures of growing flowers and opening buds, which called for very accurate timing over long periods and the elimination of all moving parts. Months of uninterrupted operation is required of such equipment.

This equipment not only produces exposures on moving picture cameras at pre-determined intervals but, through the agency of a photo tube, it also automatically times the exposure of the film to meet the conditions of light prevailing at the instant the exposure is made. Several seconds before each exposure is made, the electric lamps used for illumination are switched on.

Fig. 8 is the electronic scheme used for the system. At the top is the power reservoir for the time delay or elapse circuit.

(Continued on page 503)

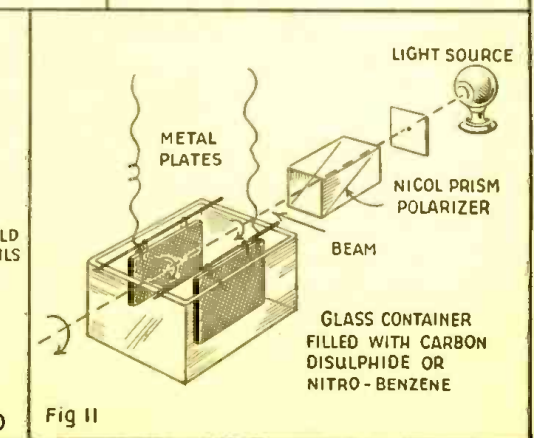
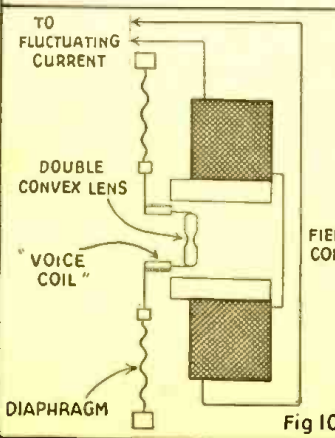
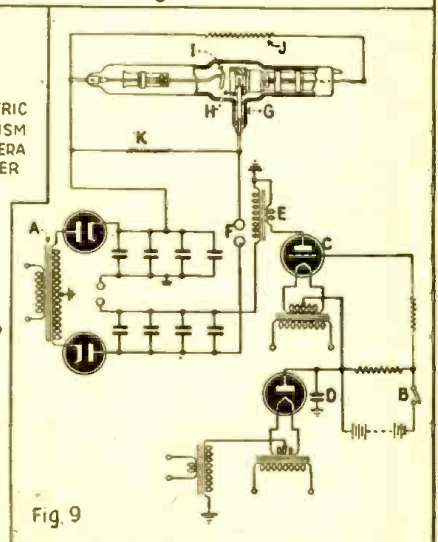
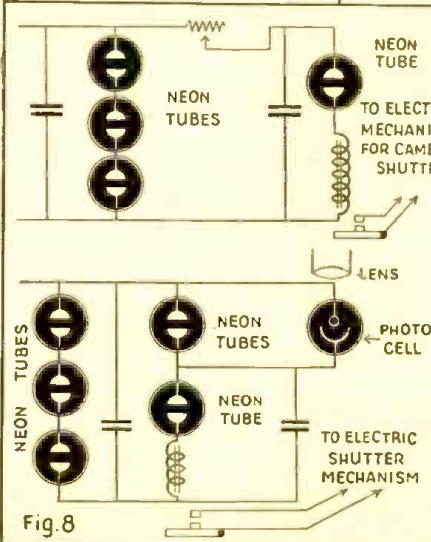
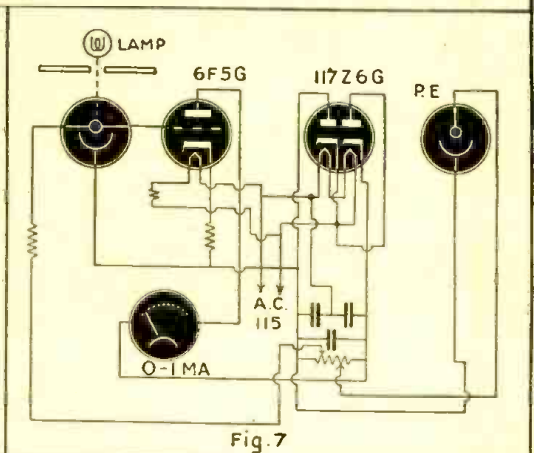
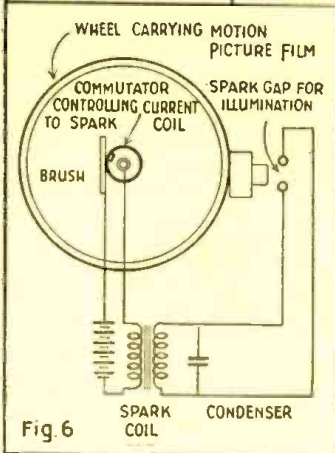
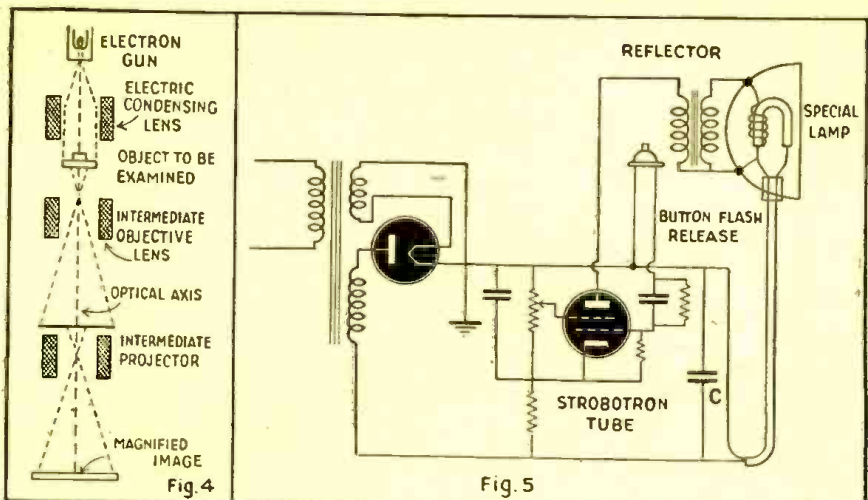



Above—Contacting headquarters from the shopping center of a town. Note hat-shop in background, with hat and price-tag under it. Right—British pack set, used in connection with the largest blackout of the Aldershot command area and the accompanying maneuvers.



British Combine Photos



Above—Canadian walkie-talkie in an "attack" on the city of London, staged by a Quebec regiment. "Airborne troops" were supposed to have been dropped over the city and are converging on an objective near its center.

CANADA'S PACK PHONE

New walkie-talkie combines native and foreign design

CANADIAN military headquarters for the first time has taken some of the wraps off a closely-guarded, hitherto secret war weapon, designed in Ottawa, and built in a Toronto plant.

Officially it is Canadian wireless set, No. 58, Mark 1.

Slangwise, it is a walkie-talkie.

To radio men it is a midget miracle, a tiny but tough combined broadcaster and receiver set, easier to operate than a hand telephone set, light but tough enough for paratroopers to take along in aerial assaults on enemy airfields, versatile enough to become—in combination—part of a military network of broadcasting and receiving stations for attacking troops.

The set, shown with an equivalent British walkie-talkie in the photos at the top of the page, is of the large type intended to be carried on a soldier's back. In this respect it is like the American walkie-talkie, which still plays an important part in military communications, though for many uses it is superseded by the smaller handie-talkies and the guidon set.

To infantrymen the walkie-talkie is like a quarterback to a football team. Before the walkie-talkie, battalions in today's swift moving warfare, would often be like a football team without a quarterback to call the signals, because of inadequate or broken-down communication lines.

Today battalion headquarters can direct units over wide stretches of battlefield with the walkie-talkie, as a quarterback sends his team plunging into action, and in addition keep continually in touch with what is developing in each area of operations.

Much of the fruitless throwing away of soldiers in battle throughout history has been due to faulty transmission of commands, or battle headquarters' ignorance of what was transpiring in front-line areas.

A dramatic example was the famous charge of the Light Brigade. Stunned commanders saw that charge begin but were

By PHIL GLANZER

powerless to stop the men. A walkie-talkie message could have stopped them before they had travelled 75 yards.

A FEW SPECIFICATIONS

Staff workers at the National Research Council in Ottawa conquered a difficult task in meeting the Canadian army requirements for a new kind of portable radio.

The new machine, the army insisted, must be lighter, tougher, smaller and more compact than the cumbersome sets they were to replace.

One requirement that was met enables the machines to become impromptu military radio broadcasting and receiving networks right in the battle lines. A dozen or more walkie-talkies scattered among attacking units over a wide front can talk back and forth freely, with the headquarters set sending out instructions to all the units at once.

Battle noises would have to be screened out, the army insisted. This was solved by having two grille openings in the microphone after the fashion of the American "electronic moustache." Noises coming into both grilles, such as battle noises, cancel each other out. When a speaker uses only one grille opening his words are broadcast distinctly.

One telescopic aerial, to be used under certain conditions, can be collapsed into a small cylinder.

Another aerial, a rod type, is in 16 sections of four different sizes. By using different combinations, different results are obtained. Maximum range is obtained with a 12-section aerial, but under battle conditions smaller aeriels probably would be safer.

Aeriels may be inserted vertically for use when the operator is in a standing position

or at right angles when the operator is in a fox-hole in a prone position.

Two power supplies are provided for the walkie-talkie. The battle battery is a dry type consisting of low-voltage, high-voltage and bias batteries in a single pack, which fits into a haversack carried on the operator's back.

The vibrator power supply is a separate unit from the set proper and is so arranged that it may be carried in a pack on the operator's back. This supply provides high voltage through a vibrator system from secondary cells of the lead-acid type. These cells may be recharged from any storage battery in the field.

NO STARTLING REVELATIONS

Much of the technical data on the instruments remain secret. Range, for example, is described only as "good reliable range for infantry working." The army experts report that performance of receiver and transmitter is "very satisfactory."

Walkie-talkies made in Canada are in use for training purposes on both coasts, but most of the machines are going overseas.

Lifting the security ban on any secret device such as the walkie-talkie usually indicates that a better product already is coming out of the factories. If that is so in walkie-talkies, the new ones probably will be a joint product of Canadian, British and United States designing and experience, for this standardization of signal equipment is one of the features of the co-operative program under way between these countries.

The auxiliary power supply is one of the features which permit heavier tubes, with a greater current drain, to be used. The apparatus is thus enabled to work over greater distances than one which has to depend on the lighter portable batteries for its power. Thus it fills the gap between the lighter handie-talkie and the heavier semi-portable field installations mounted in trucks.

Microvoltmeter

For Biological Work

THE electronic microvoltmeter here described was developed for an unusual application—the measurement of potential differences in living organisms. A device to measure such voltages must possess a number of special features, to be found in few or none of the instruments at present available.

A special microvoltmeter for the task was designed under the direction of Messrs. H. S. Burr, C. T. Lane and L. F. Nims of Yale University. Specifications for the instrument were:

(a) It must have high impedance; drawing minimal current from the specimen under test.

(b) It must have high sensitivity. As a limit, a potential difference of 10 microvolts shall be measurable.

(c) It must have high stability. Random fluctuations and general unsteadiness of the zero position shall be reduced to the lowest possible figure.

(d) It must be as nearly as possible independent of external electrical disturbances. The specimen under test shall not be "shielded."

(e) Provision shall be made so that potential differences can be read off the instrument directly in millivolts or some multiple thereof.

(f) The sensitivity of the device shall be independent within wide limits of the resistance of the specimen under test. This condition is, of course, bound up with condition (a).

(g) The device shall be readily portable and reasonably rugged.

(h) Standard radio parts shall be used in its construction as far as possible, to keep the cost at a low figure.

These requirements have been fulfilled to a high degree in the instrument illustrated in Fig. 1. The two tubes form two arms of a Wheatstone Bridge, the other two arms of which are ordinary ohmic resistors. Tube 1 receives the potential to be measured. Tube 2 acts as a dummy, the function of which is to balance out the steady plate current

of the input tube so that with no voltage impressed on the input tube, no current flows through the galvanometer G. Upon impressing a voltage on the first tube, the effective resistance of this arm of the network is changed proportionally and a deflection of the galvanometer results.

The circuit is essentially that proposed by Wynn-Williams, but for biological use departs from it in one important respect. The reason for this is that in all commercial vacuum tubes a current flows in any external circuit connecting the grid and the filament. This "grid-current" is independent—within considerable limits—of the resistance in the external circuit, and hence will cause potential differences across resistors in the grid circuit proportional to the value of these resistors. It is easy to see that if a specimen is connected across the input terminals, a fictitious voltage will register on the galvanometer, which may, in point of fact, be many times larger than the true potential difference of the specimen under measurement. To convert the Wynn-Williams bridge into a practical biological instrument, it is necessary to eliminate this spurious grid-current.

The method employed makes use of the well-known principle of the "floating grid." It is known that if the grid is isolated from electrical contact with any other element of the tube, it will acquire a certain potential (floating-grid potential). If the grid is biased by means of a battery to exactly the potential it would assume if left floating, no grid-current flows.

This is accomplished practically through the use of a variable grid bias and the switch Sw1. The set is first balanced by means of the plate controls, with the switch at position 2. Sw1 is then turned to position 3, and the set rebalanced with the grid controls. A position is soon found where moving the switch to positions 1, 2 or 3 causes no change in the galvanometer. The grid current is now eliminated.

The value of the grid leak was set at 10 megohms. This figure was arrived at by a compromise between specifications (a) and (d), these two specifications being to some extent opposed. A very high value grid leak would greatly increase the sensitivity to electrical pick-up and hence would necessitate shielding the subject under test. The 10 megohm resistor proved itself to be a good value in practice.

Choice of a tube was important. After considerable study the 112-A power triode was selected. The choice was due to its large transconductance, as well as to the fact that it is a non-heater type with a

relatively low filament temperature and has a low plate impedance. To minimize surface leaks, the tube bases were removed and the tube cavities filled with "ceresin" wax.

In the actual construction of the set only the highest grade wire-wound resistors were employed, the only exception being the 10-megohm carbon grid leak. Special care must be taken that insulation of the highest grade is provided, and that there are no leakage paths that might falsify the results. Sw1 was rebuilt with special amber insulation. When carefully built the set becomes a highly trustworthy instrument of very considerable ruggedness.

Once constructed, some preliminary adjustment and a "breaking-in" period is necessary. The filament voltage should be set at 4 and the set allowed to run continuously for 250 hours. At first the galvanometer will drift continually in one direction; after the aging process of several hundred hours this drift disappears. Thereafter, the instrument will attain stability within one minute after being switched on.

After the breaking-in period is over, the next step is to adjust the 7.5-ohm resistor, R4, for the "Wynn-Williams balance." This is done with the galvanometer at low sensitivity. The variable tap of R4 is first set at the extreme left end and the galvanometer brought to zero with the plate controls V1 and V2. The filament voltage is now dropped to 3.8 volts and the resulting galvanometer deflection is read. Suppose it is plus X1. The voltage is now raised to 4.2 volts and the new deflection noted. Call it minus X2. Now the variable tap is moved to the extreme right end and with the filaments at 4 volts the set again balanced with the plate controls. Filament voltages are again dropped to 3.8 and raised to 4.2, and the resultant galvanometer deflections charted at Y1 and Y2. Now draw Fig. 2, first drawing a horizontal line on a sheet of paper 7.5 inches long representing 7.5 ohms. (AB). Draw vertical lines at

(Continued on page 499)

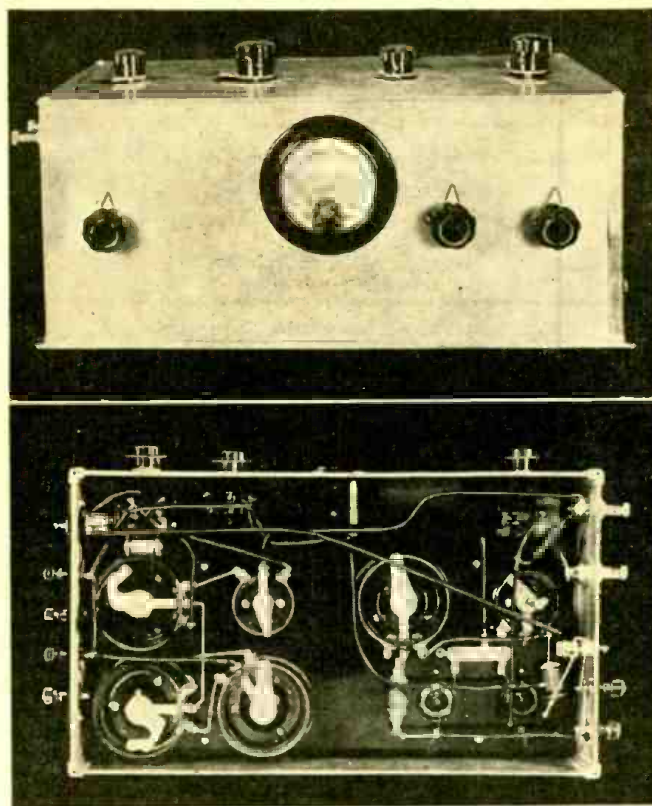

Top—Front view of the completed microvoltmeter.
Bottom—Underchassis, showing sub-panel layout.

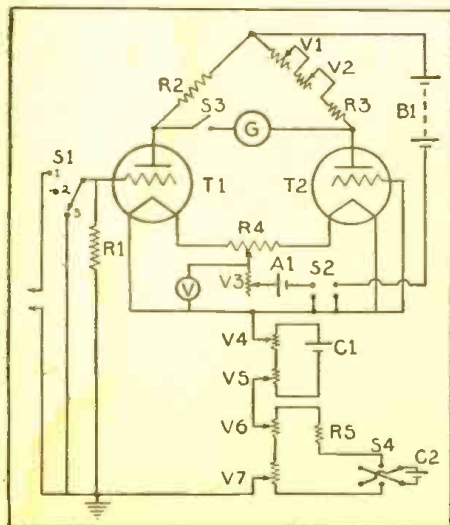

Diagram of the biological microvoltmeter.

Black Light Guards England

By KURT DOBERER

Invisible "searchlights" detect raiding Nazi planes

ON one of their heaviest raids on Berlin at the end of 1943 the R.A.F. made use of their new "magic-eye" bomb-sight, a secret weapon apparently based on the properties of infra-red rays and television. Writing in the "Dagens Nyheter," Stockholm, a Swedish scientist said: "British scientists have developed an infra-red television camera which is capable of piercing the thickest cloud and fog, and analyses the target in the same way as a blind man's fingers trace the letters of the Braille alphabet." He further declared the device to be based on three-year-old experiments of a Russian-American inventor, Dr. Vladimir K. Zworykin, at the R.C.A. Electronic laboratories in Camden, New Jersey. He and his American and British colleagues "have clearly perfected a specially sensitized screen made up of millions of photo-cells all sensitive to infra-red rays enclosed in a cathode ray tube." The photo-cells react to infra-red rays given off in different intensity by objects on the surface over which the aircraft is passing—sea, hills, valleys, forests, towns. Cathode rays playing over the photo-cells then develop the picture received and throw it on a transmission screen in the form of a motion picture of what is going on thousands of feet below.

More information about the work of Dr. Zworykin, as well as of J. L. Baird, English television specialist, and about the use of infra-red rays in defense as well as offense, is included in the following extract from Kurt Doberer's book:

A searchlight seeking out targets for its anti-aircraft guns warns the enemy and enables him to find the marks for his own weapons. This point is an important one for nocturnal air raids. It is a mistake to black-out a town thoroughly and then surround it by a ring of searchlights picking up enemy aircraft and passing them on from one to another. Most spectators know, for instance, that the searchlight on the right is located on the airdrome, and the one on the left adjoins the wireless station; and it is possi-

ble that the approaching bombers have been informed of these facts by their espionage system. The searchlights in question are already marked in their charts, and the bomb-aimers draw the inference that A.A. batteries and searchlights are there to protect either the town itself or its most strategic points. Thus the position of the searchlights tells them all they want to know. Admittedly, the pilot of a raider who is caught in the cross-beams of several searchlights finds difficulty in recognizing objectives because he is dazzled by the glare, but the comrades who follow him will do their work all the better in the darkness outside the beams. Consequently, there is only one safe method for the use of searchlights against raiding aircraft. They must be equipped with invisible rays!

During World War I the American Navy found a solution for the problem of invisible light. The ends of the rainbow band comprise rays which the naked eye cannot register, although it is possible to make them visible by means of a special apparatus. Nowadays everyone has heard something about the ultra-violet rays, which are too short to be visible, as well as the infra-red rays which are too long for visibility. The latter (now well enough known through infra-red photography) received very little attention twenty years ago, and so it was only natural for the ultra-violets to be selected for these experiments. Since such rays are only generated by powerful sources of light, the ships were equipped with arc lamps of high candle-power. The lamp on the stern of the leading ship projected its rays on to the bridge of the one following it, but the black filter fitted to the apparatus insured that not the slightest glimmer was visible to the eyes of an enemy observer. On the bridge of the second ship there was a luminous screen, painted with a coat of sulphate of zinc or tungstone of calcium. These metallic compounds emit a soft gleaming light when ultra-violet rays reach them. This was shown on the screen as long as the second

ship followed correctly in the leader's wake, but the enemy could see nothing.

The conjunction of invisible ultra-violet rays and luminous paint was employed during black-out practices in London in the summer of 1939. Patrol boats on the Thames were fitted with luminous discs. The glimmer of fluorescent paint was made visible by means of ultra-violet lamps on the banks, thus identifying the vessels and permitting a regulation of the river traffic. So this method has survived to serve in the present war.

But the invisible infra-red light is also used now in the defense system against enemy raiders. The discovery of three infra-red sensitive substances between 1919 and 1932 has facilitated great progress in the evolution of "dark lights." With the aid of these chemicals it is now possible to photograph and even film in the dark. Photographs can be taken through clouds and fog. The rays remain invisible, but can penetrate fog sixteen times as effectively as visible light. It is easily comprehensible that these infra-reds should become a potent factor in air defense.

Powerful searchlights are filtered to such an extent that they project only long-wave invisible light. The artificial eye spots the aircraft and the A.A. guns open fire before a single gleam of light shows up in the blacked-out town. In this case, the special infra-red photographic plate is not used as an artificial eye, because even if the time required for developing the picture amounted only to a few seconds, it would be too long to allow correct aiming of the guns. A television apparatus is therefore used, the infra-red rays reflected by the enemy raider being converted first into a group of current surges and then into a gleaming picture. Selenium tellurium cells are employed at the receiving apparatus because of their ability to convert the infra-red fluctuations into electric current fluctuations.

J. L. Baird, the television specialist, made practical use of this when constructing an apparatus for nocturnal vision. He used special carbons for the arc lamp of his searchlight, which gave a high proportion of long-wave light, the reflector being screened by a black filter. Since the system seemed very suitable for use in the air defense of the foggy London area, numerous experiments were carried out with this apparatus, which was known as the Baird noctovisor. In view of recent developments, it would seem likely that this noctovisor has undergone considerable improvements, but naturally the details remain secret.

There is one possible drawback to the complicated infra-red searchlight. Raiders could be equipped with recording apparatus for infra-red rays and so obtain a footing of equality with the defense. Such recording apparatus has, in fact, been used in British bombers, thus enabling them to make safe night landings on blacked-out airdromes. For this purpose invisible long-wave light is focused in the landing direction. Aircraft coming in at the right angle catch this light by means of the artificial eye and so land smoothly in complete darkness.

The U.S.A. made great efforts to develop the infra-red system for defense. In the summer of 1935, the press contained allusions to experiments in the laboratories of Fort Monmouth, New Jersey. Some months later, the military authorities permitted the publication of a report on the use of the new device in maneuvers:

Under cover of darkness a sham fight took place in the vicinity of New York, during which the "secret rays" of a new
(Continued on page 490)

POST WAR USES

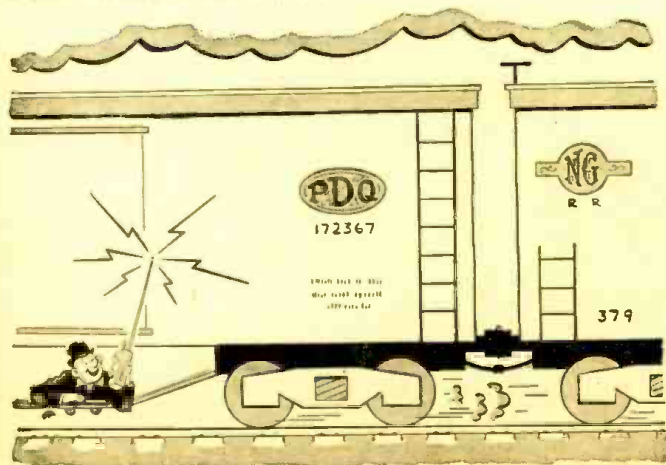

"Say, Bo, we better get off at the next junction"

Smaller Packs For Portables

By R. S. HAVENHILL

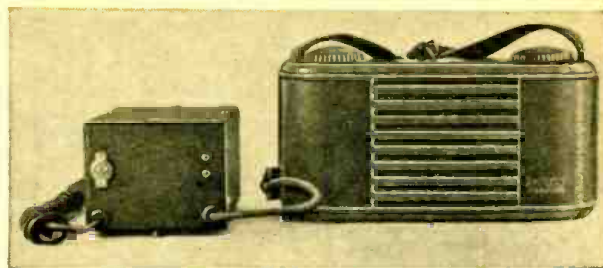

A neat and "commercial" appearance features this little job.

A LARGE number of miniature personal portable radios were given our boys as presents when they went into the armed forces. The A and B batteries on these sets have since gone dead and cannot be replaced. These boys like their radios and are clamoring for either a new small AC set or an AC power pack to operate their personal portables. The small AC sets are not available. Even if they were, there is some question as to whether to buy a new set when only a power supply is needed.

Since the power packs can no longer be purchased either, it is the purpose of this article to describe the construction of a small rugged power pack to operate these receivers from 115 volt 60 cycle A.C. power lines. The pack herein described was designed to operate a Philco "Transitone" portable radio Model PT-89 (41-89). The design is also applicable to other miniature battery portables. Refer to the October 1940 issue of *Radio-Craft* for schematic of this set and also the RCA, Emerson and Automatic Radio "Tom Thumb."

DESIGN CONSIDERATIONS

These sets require an A supply for the filaments of 1.4 volts at 200 to 250 Ma., (200 Ma. for the Philco) and a B supply of 45 to 67.5 volts at 10 Ma. No special provision need be made for C bias if the A & B supplies are independent, as the bias for the power tube is obtained either by an 800-ohm resistor in the B-lead or by a filtered voltage taken from the oscillator grid of the converter tube. (See schematic of Sentinel Model 227-P in the February 1941 issue of *Radio-Craft* for the latter biasing method.) The most important considerations are that the unit be small and rugged. All tubes and other parts must be completely enclosed in a small metal box so that they will not be broken or damaged when the unit is banged around in an army camp.

The power packs described by Fred Shunaman in the January 1943, and by the writer in the April 1943 issue of *Radio-Craft* are excellent for these sets but they are not compact and rugged enough for army camp life. The tubes and component parts used generate considerable heat which is difficult to dissipate when these units are completely enclosed in a small cabinet.

THE FILAMENT SUPPLY

To obtain ruggedness a small 6.3 volt filament transformer and a selenium dry disc rectifier were used in place of a tube for the A supply. Since the current from the dry disc rectifiers is difficult to filter, a two-section filter was necessary. The first section consisted of two 1,000 Mfd. condensers and a small choke. The second section consisted of a 15-ohm adjustable resistor set at 10 ohms and a 1,000 or 2,000 Mfd. condenser. A bleeder of 20 ohms was used to keep the peak voltages below the filter condenser ratings if the unit should be turned on when not connected to the radio set.

A bridge type rectifier is preferred and can sometimes be found in the junk box. The rectifier taken from an old trickle charger, electric train power pack, telephone rectifier or dry disc rectifier from an old speaker field supply can often be used. The unit may be either a copper oxide, copper sulfide or preferably a selenium type. If the unit will put out 1.4 volts at 200 Ma. without heating up when connected as shown in the schematic, it is probably satisfactory. This can be checked by placing a resistor equal to the filament load: $1.4/200 = 7$ ohms, across the output. Adjust the 15-ohm variable resistor to give 1.4 volts

heat generation and is especially designed for portable equipment. A conventional half wave circuit is used. The filter consists of two 40 Mfd 250 volt condensers (20 Mfd's if you can get them) and a 7,500-ohm resistor in place of the usual choke. The value of the series resistor to cut down the 115-volt line to 45 volts for the rectifier filament is $115-45/0.75 = 933$ ohms. A 1,000-ohm 10-watt unit will be all right. A 960-ohm or 1,000-ohm line cord resistor would be preferable if it can be obtained. A fused line cord plug is desirable if available.

The complete unit can be housed in a 3- x 5- x 4-inch metal cabinet. One end of

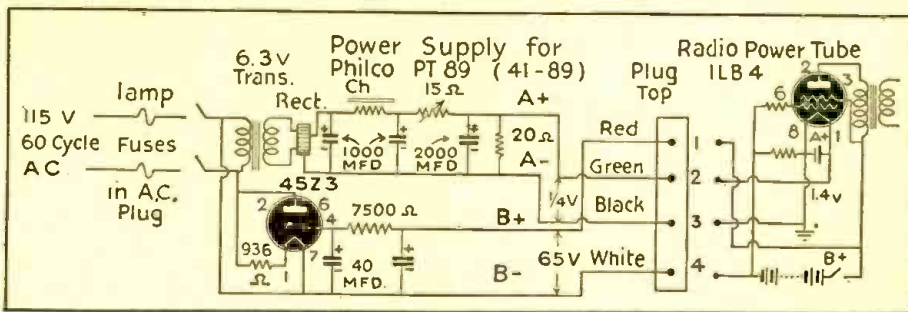

Schematic diagram and layout of the small power pack. This type can be adapted to a large number of 1.4-volt portables, and by changing the rectifier, to 4- or 6-volt sets.

across the 20 ohm bleeder and note whether or not the rectifier heats up. If the rectifier is very old it will probably have high resistance and the 20-ohm bleeder may have to be omitted to obtain 1.4 volts.

The choke is necessary for complete elimination of hum. This is a low resistance choke and cannot be purchased readily. However, it can be made easily by removing the winding from a midget "B" supply choke and replacing it with a winding of as many turns of No. 25 enamel wire as can be wound in the core space. The coil is wound on a small cardboard form or on a paper-covered wooden mandrel the same size as the core post in the choke. (Refer to "Wartime Transformer Rewinding" in the August-September, 1942, issue of *Radio-Craft* for coil winding details.) If a good grade of insulated wire is used no paper is necessary between successive layers. No hum could be detected in the "A" circuit with a cathode-ray oscillograph having the amplifier gain turned on full.

THE HIGH-VOLTAGE SUPPLY

The 45Z3 rectifier was chosen to furnish the B current. It is very small, has low

the cabinet is removed and fastened to the bottom cover, and all parts are then mounted on these two plates. The completed unit can then be slipped into the cabinet case and fastened together with self-tapping screws.

LOCATION OF PARTS

The location of the parts is very important in a small unit such as this. In the first place, it is difficult to get them all into the box and in the second place they must be properly positioned so that the heat from the 45Z3, 933-ohm filament dropping resistor

(Continued on page 496)

... FOR HANDY-TALKIES

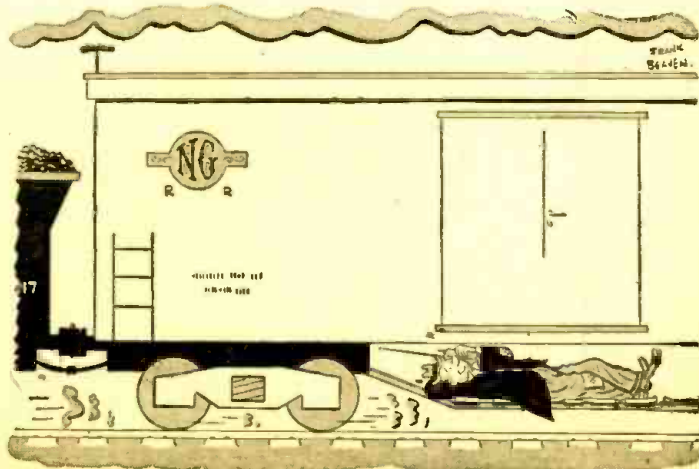

... they give you a swell handout in town."

Tube Substitutes

By JACK KING

MANY types of tubes are scarce and substitutes must be used. Slight changes in sockets, and wiring, or circuit changes and installation of series, shunting or line resistors in the filament circuits give the serviceman with common sense a wide range of replacements to select from. A representative group will be considered below:

PENTAGRID CONVERTERS

The 1A7-GT is scarce. The 1A7-G is a suitable substitute, having a slightly larger bulb size. Electrically, the tubes are practically the same, but realignment may be required for best results. The 1B7-GT or 1B7-G may also be used. The 1B7 draws about twice as much filament current and twice as much current from the B battery system. Its G_m at zero bias is 350 mhos, compared with 250 for the 1A7, so that the gain is somewhat higher. If the tube filaments of the receiver are operated from a 1.5 volt battery source and are parallel connected, the 1B7-GT or 1B7-G may be plugged in the 1A7-G or 1A7-GT socket without any change in the circuit or socket connections.

If the set is an A.C.-D.C.-battery portable, it is impractical to substitute the 1B7 because the filament current is .1 amp., and overloading of the rectifier may result. This would shorten its life.

The 1LA6 is practically identical with the 1A7-GT and 1A7-G. The only change required is that a new socket of the loktal type be installed. The small size of the tube will allow it to fit into almost any portable. Realignment is necessary because of disturbance of the receiver wiring in making the change and because of slight

differences in inter-electrode capacitances.

The 1C6 requires 2 volts at .12 amp. for the filament. It could be used as a 1A7 substitute if a 2-volt source is available capable of supplying the required current. The same thing may be said for the 1C7. Usually, such changes are impractical. The remaining filaments of the receiver, 1.5 volt types, would require a series voltage dropping resistor. Then, the filaments could be operated from a single cell (2 volts) of a storage battery on a farm, but such applications in three way portables would be out of the question.

HIGHER-VOLTAGE MIXERS

The 12SA7 is another scarce mixer type. Its heater requires 12 volts at .15 ampere. The tube is electrically equivalent, except for the filament, to the 6SA7 which requires 6 volts at .3 ampere. The 12SA7 is directly replaceable with the 12SA7-GT. The 12SA7-G is the same as the 12SA7-GT. There is one minor difference, however, the 12SA7 is metal and has the suppressor grid connected to pin terminal 1 and the shell of the tube. The 12SA7-GT and 12SA7-G have no pin connection to terminal 1, the bulb is glass, and the suppressor is tied directly to pin 6 and the cathode. The 12SA7-GT can be plugged in the 12SA7 socket without any change.

If the 12SA7 is used in place of the 12SA7-GT, pin terminal 1 must be connected to ground (B minus). The 6A8 and 12SA7 both have five grids and are pentagrid converters (penta meaning five). The 6A8 has a separate anode grid and no suppressor, the 6SA7 and 12SA7 have suppressors, but not separate anode grids. The 6SA7 may be used in place of the 12SA7, or the 6SA7-GT can be used, but the filament circuit of the receiver must be modified when this is done. A typical set uses the following line-up: 12SA7, 12SK7, 12SQ7, 50L6, 35Z5.

Space limitations must be kept in mind when making a tube substitution. If the set is a console, it may be possible to mount a resistor or transformer on the inside of the cabinet when there is no room on the receiver chassis. Using resistors or transformers in very small sets is impractical and the best thing to do is to try hard to select a tube that will do the job with a minimum of fuss. Assuming space permits, the original circuit of Fig. 1-A may be modified in several ways, as shown in Fig. 1-b, and Fig. 1-c. The 7Q7 may be used instead of the 6SA7 or 6SA7-GT, provided a new loktal socket is installed.

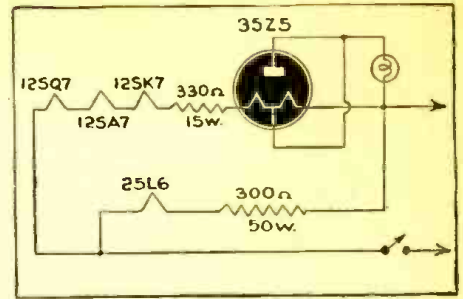

Fig. 2—Here a 25L6 is inserted in place of a 50L6 by using an independent filament line.

The 7B8 may be used in place of the 7Q7 if the anode grid is tied to the screen grid. The 12A8-GT may be substituted for the 12SA7. There is no suppressor in the 12A8-GT. The anode grid is tied to the screen grid to make the tube equivalent to the 6SA7 or 12SA7. The connections at the socket must be checked (refer to a tube manual.) Pin 6, for example, goes to the cathode of the 12SA7 and pin 8 goes to the cathode of the 12A8-GT. The socket is the same, octal, but the pin connections are somewhat different. When the 6A8-GT is used, the filament circuit is modified in the same way as for the 6SA7. The 12A8-GT requires no filament circuit change, since the tube draws .15 amp. at 12 volts.

R.F. AND I.F. AMPLIFIERS

The 12SK7 is a scarce type and may be replaced with the 12K7-GT, 12K7, 6SK7, 6SK7-GT, 6K7, 6K7-GT, 12K7-GT. Other equivalent types are the 6S7, 6SG7, 7A7, 12B7, 12B7/14A7, 12B7-ML. The 12B7 is a loktal type which would require a new socket, but otherwise is very similar to the 12SK7. The 12K7-GT would be an easy substitute for the 12SK7. The 7B7 could also be used. The 7B7 draws .15 ampere. With a 2 watt, 40 ohm resistor hooked in series with a filament, the 7B7 may be used as a replacement for the 12SK7 with no other circuit change, except a new loktal socket. If the 7A7 is used, the filament circuit change would be the same as for any 6 volt .3 amp. tube.

A.F. AMPLIFIER-DIODE DETECTORS

The 12SQ7 is a scarce type. It may be replaced with the 12SK7-GT, 12Q7, 6Q7-GT, 6SQ7-GT, 7B6, 7C6, 14B6. The 12Q7-GT change would require no filament circuit modification and the socket would be the same. The 6Q7GT would require a filament change but no socket change, as would the 6SQ7-GT. The pin connections on the latter tube would have to be checked, as it is a single ended type, of course.

The 7B6 would require both a new socket (loktal) and filament change for a 6 volt tube at .3 ampere. The 7C6 would require a 40 ohm, 2 watt series filament resistor and new socket. The 14B6 would require only a new socket as it has a 12 volt, .15 amp. heater.

(Continued on page 500)

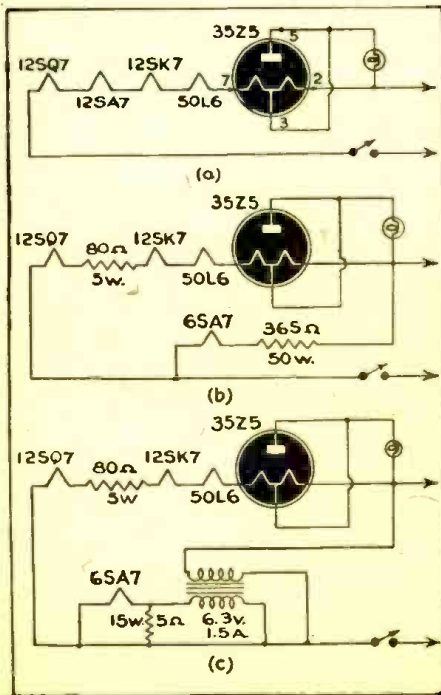

Fig. 1—Three ways to use a 6SA7 in place of a 12SA7. This applies to other 6-volt tubes.

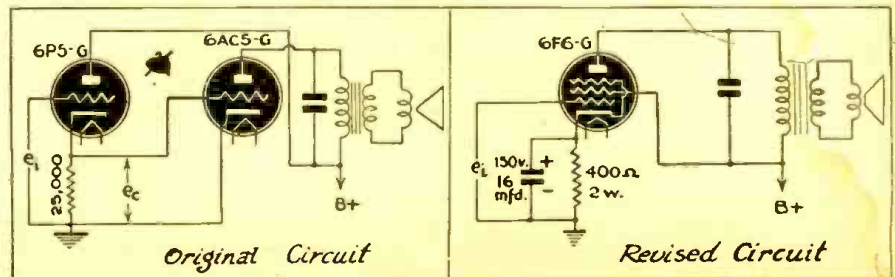

Fig. 3—The direct-coupled circuit with a 6AC5 may be replaced with an ordinary 6F6.

Audio Distortion

PART II—VARIOUS TYPES OF FREQUENCY DISTORTION

By TED POWELL

FREQUENCY discrimination distortion is most evident as a high- and low-frequency cut-off at the extreme ends of the range passed by an audio system. It may also be present as "highs" and "lows" in the frequency response. It is closely tied up with harmonic distortion and aids in the creation of unpleasantly sour "peaks" in the signal output of an amplifier or audio component.

Frequency distortion is characteristically associated with high amplification. Generally speaking, the higher the amplification of an audio component, the higher the frequency distortion. This is true for the reason that shunt capacitance effects take control at the high frequency end of the audio range and cut off these frequencies, and shunt impedance effects do the same at the low audio frequencies. So the higher the amplification of any individual audio component or circuit, the greater becomes the relative amplification of the middle audio ranges as compared with the high and low frequency ranges. As a result, the "bends" or "knees" at both ends of the audio range become relatively greater and therefore frequency and other audio distortion effects become greater. Such frequency distortion effects can be compensated for to a certain extent by special compensating circuits. However, in hi-fidelity audio work, it is usually inadvisable to design amplifier tubes or audio components or circuits with too high a gain characteristic.

This distortion effect is troublesome in the case of high-gain audio transformers, electro-mechanical transducers and high-gain power amplifier pentodes. Generally speaking, where high amplification per stage is avoided, frequency distortion presents no particular design problems.

PHASE-SHIFT DISTORTION

This is not ordinarily a serious factor in audio work. Considerable phase-shift must take place before the resultant audio wave-form distortion can be detected by the human ear. As a rule, phase-shift need be considered only in the case of certain ultra-short-wave circuits and long-distance transmission lines.

An expert ear can detect this type of audio distortion as a characteristic "barrelly" and muffled quality at the lower audio frequencies. At higher frequencies it can be detected as a peculiar "birdie" and "tweet" type of echo hash. It is particularly noticeable in the case of radio broadcast signals that have been piped over long-distance transcontinental phone lines. It can also be noted to a limited

extent in the case of audio amplifiers with too many audio transformers or too many frequency-corrector networks.

While phase-shift can be checked with an audio oscillator and oscilloscope at several frequency levels, or by running a laborious frequency-vs.-phase-shift curve, a much more rapid and effective check can be made by firing square-wave signals through the amplifier and noting the deformations of the square waves on a scope screen.

General Radio Co. electronics engineers have noted the interesting fact that an audio system's frequency response fidelity at any frequency range is roughly proportional to the amount of phase-shift distortion it develops at that frequency range.

This fact emphasizes the point that most of the audio distortion effects appear to be inter-related to a certain extent.

"VOLUME" DISTORTION

This is a minor audio distortion effect suggested by the writer. It might also be called "dynamic" distortion. It is a non-linear amplitude-vs.-time variation distortion of any given frequency signal passing through a network. That is, when rapid volume variations of a signal are not faithfully reproduced, we have "volume" distortion. It may only be a special case of a transient type of phase-shift distortion.

It can be especially noted where high-

This section of Mr. Powell's article discusses frequency-modulation distortion, a newer arrival in the experience of sound engineers. A number of overlooked causes of this type of distortion are pointed out. Another very often overlooked form of distortion, caused by frequency-shift, is here also called to the attention of the sound man. Some less important forms of distortion are also mentioned, as well as the standard frequency distortion, by which it has been the practise (often misleadingly, believes Mr. Powell) to rate amplifiers.

amplitude, steep wave-front signals such as set up by percussion-type musical instruments, sharp noises or loudly uttered speech which begins with percussive type consonants, are fed into an audio system.

FREQUENCY-MODULATION TYPE

This is a comparatively new addition to the audio distortion field. It was first noted in the case of electro-mechanical transducers.

When a speaker voice-coil is fed by complex-frequency signals, its cone cannot vibrate as a whole for all frequency levels. At the higher frequencies, its mass is too great for it to follow the relatively rapid frequency swing. Not all of the cone can vibrate at that rate. It will flex at some point near the voice-coil. At the same time the cone will vibrate as a whole at frequencies of the lower signal component, since its mechanical resonance period lies within that frequency band. As a result, the higher frequencies will be frequency-modulated by the lower frequency signal components. Similar FM audio frequency distortion takes place in microphones and phono pick-ups.

In sound film and phono recording and play-back, gear-tooth torque pulses, drive-motor hunt and variable stylus loading effects cause "wow" and "hash" which can be considered to be a form of FM distortion. Cyclic variation of the turn-table or film sprocket speeds cause cyclic variations of the recorded audio frequency signals and thereby cause this type of distortion. Thus an old acquaintance of the sound man turns up in a new guise.

Other possible sources of FM audio distortion must be taken into consideration. Magnetic hysteresis in audio transformers and dielectric hysteresis in condensers may also introduce it in audio systems. When complex frequencies are introduced into magnetic-core units, a highly complex magnetic flux effect takes place within the magnetic core material and the inductance offered to the various frequencies varies cyclically at the frequencies of all the other frequency components. A similar effect

(Continued on page 498)



"He's asking the chief how well he wants him done."

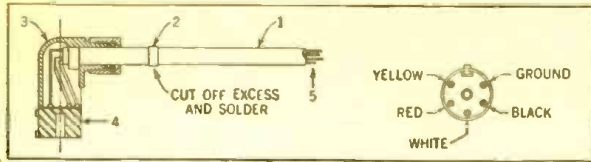
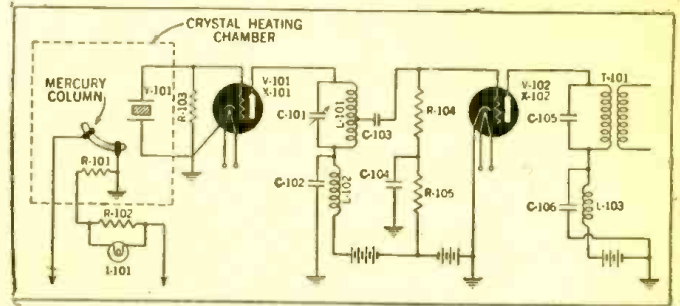

Fig. 1, below—Diagram of an ordinary radio circuit, showing how separate units are shown in a "housing" of broken lines. The same symbol is often used in radio drawings to show ordinary shielding. The use of explanatory numerals and letters is also demonstrated. Note the alternate socket types, listed V-101 and V-102. Fig. 2, left—How callouts may be used on installation drawings.

Electronic Diagrams

By CARL H. WINTER



TWO tables were published in the article last month. One of these was a list of symbols used in electronic circuits. The type used in communications was followed, though diagrams of apparatus using electronic tubes are occasionally seen in which the symbols are those used in diagrams of electric power machinery. These will be shown in this article.

The second table was a list of letter designations commonly used to designate parts of apparatus represented in the schematics.

Numbers for the letter prefixes are usually assigned in the following manner:

Where one major unit is concerned, the numbers are assigned to a particular type of component, consecutively from 101 to whatever quantitative number is required to cover the amount of components of that type used. For example, if twenty resistors are used in one circuit, the numerals which follow the prefix letter R (refer to table 2),

will run from R-101 to R-120. Twenty condensers would similarly run from C-101 to C-120.

The assignment of numerals and letter prefixes is usually accomplished by listing them consecutively for the one type of component, starting at the upper left of the schematic and identifying each component in turn vertically, returning to the top of the drawing when the bottom of each arbitrary section is reached and starting again at the upper left of the schematic for another type of component.

A good deal of freedom of usage is allowed by this method and broadly speaking, any logical sequence is permissible but the method described is generally adhered to. (Refer to figure 1.)

If more than one major unit is shown on the schematic or if several schematics applying to the same project are under con-

sideration, the symbol designation numerals will run in the 100 class for the first unit; the 200 class for the second unit, and so on until each major unit bears its own numerical classification.

It is amazing to what extent the use of symbol designations and a fixed, standardized method of letter and number assignment facilitates the use of parts list tables.

A part of a unit which is housed or mounted separately or detached in any way from the major unit is usually squared off by a dotted line to indicate which components are detached from the main portion of the unit. (Refer to figure 1.)

Callouts, that is, explanatory text on the margin of the drawing designated by arrows pointing to a particular component, are rarely seen on circuit schematics. These callouts are most commonly used in con-

(Continued on page 501)

One Line Symbol	Complete Symbol	
1.		A.C. Generator or Motor
2.		D.C. Generator or Motor
3.		Induction Motor
4.		Synchronous Converter
5.		Direct Coupled Units
6.		Single phase. Two winding Transformer
7.		Oil Circuit Breaker, single throw
8.		Air Circuit Breaker
9.		Fuse
10.		Resistor
11.		Rheostat
12.		Reactor
13.		Capacitor
14.		Instrument Shunt
15.		Bus (with branches)

Table 3—Power symbols, often confusing to radiomen.

1.	Ceiling Outlet
2.	Ceiling Lamp Receptacle
3.	Ceiling Outlet (extension)
4.	Pull Switch
5.	Drop Cord
6.	Wall Bracket
7.	Wall Outlet (extension)
8.	Wall Lamp Receptacle
9.	Single Convenience Outlet
10.	Double Convenience Outlet
11.	Junction Box
12.	Special Purpose Outlet
13.	Floor Outlet
14.	Local Switch, single pole
15.	Local Switch, double pole

Table 4—Electrical wiring diagrams use the symbols above.

16.	Local Switch, three way
17.	Motor
18.	Motor Controller
19.	Lighting Panel
20.	Power Panel
21.	Pull Box
22.	Meter
23.	Transformer
24.	Branch Circuit Under Floor Above
25.	Branch Circuit Under Floor
26.	Branch Circuit Run Exposed
27.	Feeder Run Exposed
28.	Feeder Run Under Floor
29.	Buzzer

Electronic Circuit Checks

Part IV Cathode-Ray Tubes and Their Uses

By R. E. ALTOMARE

THE visual dynamic method of analysis is fast becoming popular because it is so naturally adapted to the servicing and adjusting of special equipment such as might be used in war applications.

The technique is similar to that of signal tracing, but in this case we make use of an even more efficient output meter, that is, an indicator wherein the signal may actually be observed.

This method may be employed where it is desired not only to know if a signal exists and what its intensity is, but also what

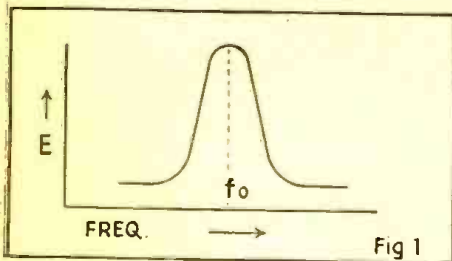

Fig. 1—A resonance curve, of the kind used when measuring selectivity of radio circuits.

type of signal appears in actual operation. One is correct in surmising that this system is well suited to checking distortion as well as oscillation, regeneration and allied troubles. It may also be used with equipment wherein a definite type of signal—possessing a definite wave form—is desired, and this signal must be obtained by adjustment. A common example would be the high fidelity receiver, in which the I.F. amplifier is designed to give a wide pass band or broad resonance curve.

In checking special equipment such as square wave generators or the wide band amplifier of television and other devices, poor results would be forthcoming unless the channels all perform in accordance with their design, and Visual Dynamic Analysis would be the most efficient means of checking.

METHOD OF PROCEDURE

As in signal tracing, it is necessary to have a signal source consisting of an all-wave generator, with provision for modulation, if necessary. The indicator must show the actual signal passing through any stage or stages of the device under test. Cathode-ray Oscilloscope (CRO) is thus a vital essential to the correct application of Visual Dynamic Analysis. As we shall now show, a Frequency Modulated signal generator is sometimes extremely useful.

An example of the application of Visual Dynamic Analysis is the broad band I.F. amplifier of a high-fidelity receiver. In

former days we would determine the resonance curve of such an amplifier by applying an R.F. signal to the input of this amplifier and measuring the output voltage with a vacuum tube voltmeter, starting with a frequency somewhat below the resonant frequency (intermediate frequency) and increasing it in steps to a value somewhat above the resonant frequency. If we read the output voltage for each frequency and drew a graph of the results, we would have the resonance curve of the amplifier and this would appear as in Figure 1.

Suppose the characteristic desired was not obtained, due to trouble in the amplifier. It would be a tedious task to draw a resonance curve by the old method every time we made an adjustment. An automatic method of doing this would save time. For one thing, we could manually change the frequency of the signal generator for frequencies between the limits of the curve, and replace the vacuum tube voltmeter with a CRO. A frequency-modulated signal generator performs the operation for us automatically.

Figure 2-a shows how we may connect an FM signal generator to an I.F. channel with a 'scope connected to show the rectified output across the diode load resistance of the 2nd Detector. The sweep voltage applied to the horizontal input of the 'scope is the voltage used to frequency modulate the signal generator, and is available from a binding post in all commercial FM signal generators. Figure 2-b shows the resultant resonance curve of a typical peaked amplifier while Figure 2-c illustrates the resonance curve of a wide band amplifier. Note that the resonance curve appears upside down. This is a characteristic of the 'scope. In practice the Signal Generator is set to the I.F. of the amplifier.

Remember that we may check any tuned amplifier in this way. This includes receivers, from the antenna to the 2nd detector. The signal generator may be connected to the mixer tube grid and set to the I.F. frequency, or it may be set to the frequency to which the receiver is tuned. Connection may also be made to the R.F. amplifier or the antenna if we tune the receiver and signal generator to the same frequency.

It is recommended that we check one stage at a time for this analysis, first setting the signal generator to the I.F. frequency and connecting to the control grid of the 1st I.F. amplifier, then working backwards towards the antenna.

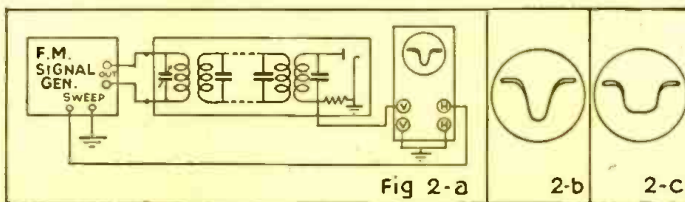

Fig. 2a—How a 'scope and frequency-modulated generator are used. Figs. 2b and 2c—Resonance in sharp- and broad-tuned amplifiers. Fig. 3—This family of curves illustrates how clearly the symptoms of radio troubles show up on the cathode-ray tube's viewing screen.

With the aid of Figures 3-a to 3-n it can be seen how we trace a defective stage or part which may cause various forms of distortion.

Figures 3-a, b and c show the normal curves of an ordinary broadcast receiver, a narrow band communications receiver and a band-pass high-fidelity amplifier respectively.

Figure 3-d shows the effect of over-coupling in a band-pass amplifier.

Figure 3-e shows the trace which will result from improper alignment.

Figure 3-f illustrates the effects of phase distortion. A normal amount is not detrimental to the operation of the receiver but opening up of the traces to ¼-inch or more becomes serious and may be caused by defective coupling or open by-pass capacitors, especially in the screen or cathode circuits.

Figure 3-g illustrates trouble due to defective filtering of the power supply.

ALIGNMENT METHODS

Figure 3-h shows improper alignment as well as regeneration in one of the stages under test and in most cases is caused by an open by-pass capacitor or stray coupling. A peculiar case once showed a trace somewhat similar, but slightly more distorted, than this figure, and was traced to shorted turns in the primary of one of the I.F. transformers. When checked further, this coil showed a low Q.

Figure 3-i shows a trace which is typical of oscillation in one of the stages under test. Note the jagged lines at the bottom.

(Continued on following page)

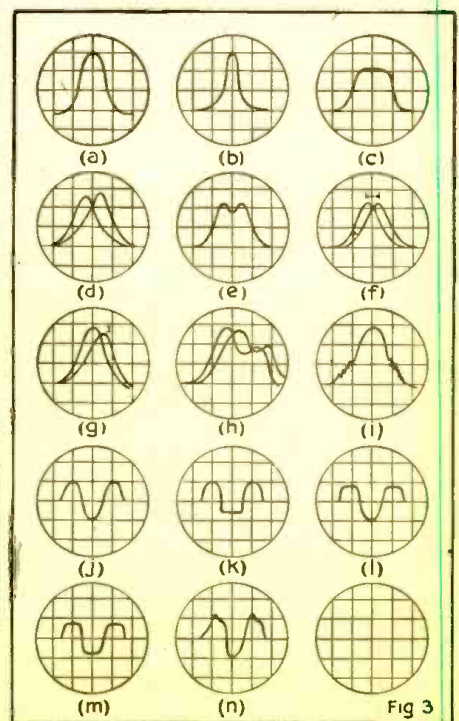

(Continued from previous page)

which in practice will be found to jump up and down on the screen.

Since faulty alignment is illustrated, we see that alignment is possible with Visual Dynamic Analysis. In fact, the wide band amplifier can be correctly aligned only by this method. We watch the trace on the screen and adjust our trimmers until exactly the response curve we desire is obtained.

Causes of faulty operation of the detector and audio stages may be found by using the basic instruments mentioned. The audio-frequency output of the signal generator is connected to the input of any stage and the 'scope connected to the output of any stage, then the patterns on the screen noted. Any procedure may be used, but from experience it is suggested that the A.F. signal be injected into the input of the audio amplifier and the 'scope connected across the output of the power amplifier. Now move the S.G. leads progressively towards the power amplifier, and when the suspected stage is found, move the 'scope back to the output of that stage, concentrating upon it.

As in signal tracing, we are not limited

to the whole stage only, but the 'scope may be connected across individual parts, then results noted. For example, if connecting the 'scope across the screen grid by-pass capacitor of an A.F. amplifier stage shows a wave indicating an A.F. voltage, that condenser is probably open, or at any rate, its by-passing effect is insufficient.

The set-up just explained works well in reducing the "sphere of fault" due to distortion, intermittent operation, regeneration or motorboating and other troubles which appear in A.F. stages.

Figures 3-j,k,l,m, and n show some typical patterns in an audio system.

Figure 3-j shows a pure sine wave output. (There is no distortion of the sine wave A.F. applied to the stage.)

Figure 3-k shows the results of insufficient bias to a Class-A amplifier stage.

Figure 3-l shows the opposite case, where the grid bias is too high.

Figure 3-m is a typical trace of an overloaded stage.

Figure 3-n shows the effect of insufficient by-passing and is usually traced to an open screen or cathode by-pass capacitor.

Thus far in our study of Visual Dy-

amic Analysis we have considered an FM-AM signal generator and a 'scope as our tools. This was done to illustrate the use of these essential tools. It should be clear that we may use this form of analysis as readily as we used the signal tracer.

If we incorporate an R.F. channel, together with our 'scope (the vertical amplifier in the 'scope will pass audio frequencies) we have a complete Visual Dynamic Analyzer. In most commercial models the R.F. channel is not of the type found in the signal tracer, which is tuned, but is a video amplifier, or a wide-band amplifier which will pick up most radio frequencies. Also incorporated is a demodulator to remove the audio modulation from the signal if necessary. Some manufacturers include the frequency modulator and a mixer in the unit. An instrument of this type is the Hickok RFO 5.

With such an instrument we would have a complete visual signal tracer which can reduce the "sphere of fault" in any device to be serviced to a point where we may point to the defective part and say definitely, "There's where the trouble lies."

TRANSMITTER ANALYSIS

So far the servicing of transmitters has not been mentioned specifically, although they fall under the types of electronic equipment to which our methods apply. Visual Dynamic Analysis is often applied to the transmitter to check modulation and distortion. Figure 4-a shows the hook-up for one method, while Figure 4-b shows it for the other method. Notice that the transmitter supplies its own signal and only the 'scope is used.

The method of Figure 4-a, called the Envelope Method, a coil of a few turns is coupled to the tank of the final R.F. amplifier and connected directly to the vertical plates of the 'scope. The sweep generator of the 'scope is used and the resulting pattern is shown in Figure 5-a. We see an envelope of the modulated wave. Figure 5-a shows 100% modulation while less than 100% modulation and overmodulation are shown in b and c of the same figure.

Figure 4-b is called the trapezoid method and the connections are the same except that we use a portion of the modulating signal for the horizontal sweep. The resultant pattern is shown in Figure 6-a for 100% modulation while b and c of that figure show less than 100% modulation and overmodulation respectively. The condenser C in both cases is used to increase the voltage available where necessary.

Referring to 5-b and 6-b the percentage of modulation may be calculated since

$$\% \text{ mod.} = \frac{E_{\text{max}} - E_{\text{min}}}{E_{\text{max}} + E_{\text{min}}} \times 100$$

$$E_{\text{max}} + E_{\text{min}}$$

The trapezoid method is most often used, since it lends itself more easily to interpretation of distorted patterns, either in the R.F. or modulator sections of the transmitter. The many patterns which may show improper operation and their interpretation will not be discussed here. The reader is referred to the "Radio" or A.R.R.L. "Radio Amateurs Handbook" for a further discussion.

Audio amplifiers may be checked for frequency distortion with the Visual Dynamic Analyzer and a frequency modulated A.F. signal obtained by beating the FM oscillator set to 1000 Kc. with an external oscillator also set to 1000 Kc., connecting both outputs to the input of the A.F. amplifier and the output of the amplifier to the 'scope terminals. If the FM generator is frequency modulated at 15 Kc. the patterns should be

(Continued on page 493)

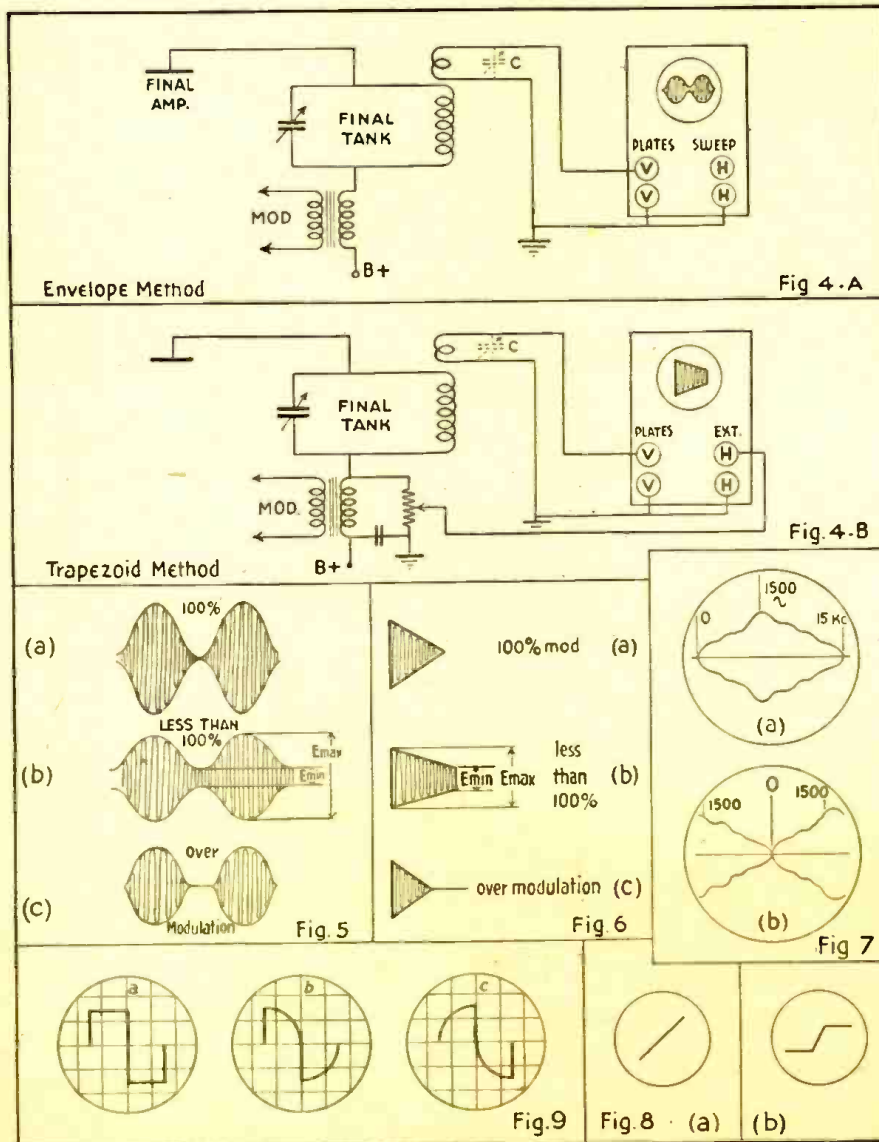

Figs. 4a and 4b—Connections for envelope and trapezoid methods of modulation analysis. Figs. 5 and 6—The characteristic cathode-ray patterns produced by the circuits shown above. Fig. 7—Cathode-ray pattern obtained in making distortion checks on an audio amplifier. Fig. 8—How overload appears on the screen. Fig. 9—Distortion checks with square waves.

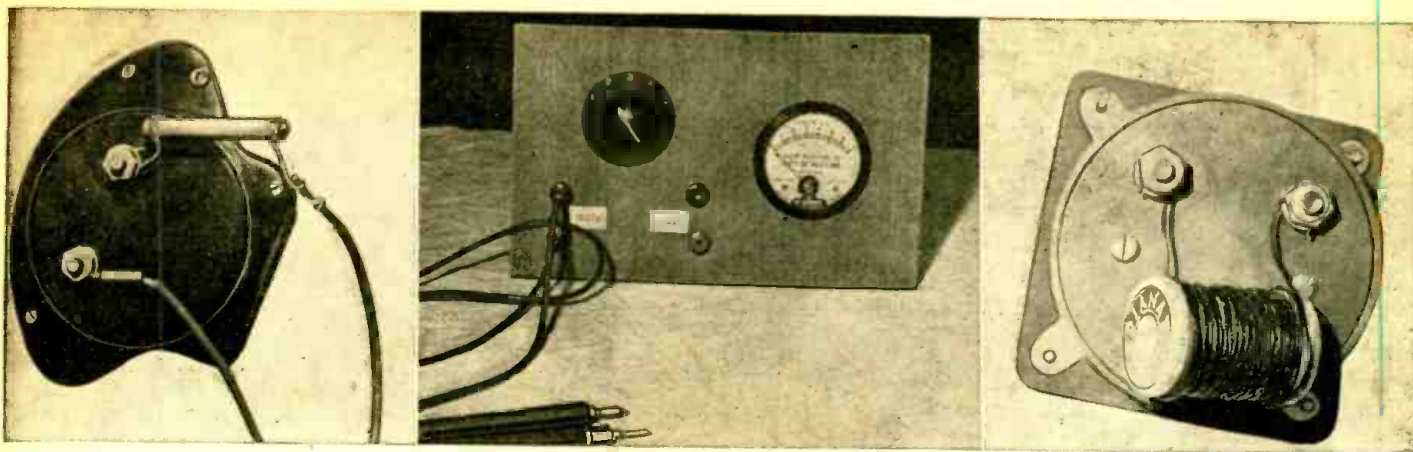

Left—A voltmeter is a millimeter with a resistor in series. Middle—A completed multitester. Right—How shunts are employed.

“METEROLOGY” FOR ALL

By M. ROSENFELD AND ARTHUR HOWARD

HAVE you ever experienced the need for a wide-range milliammeter or a voltmeter and have been unable to purchase such equipment at present? Your troubles will be over if you have a simple D.C. meter. You can easily convert it into a wide-range milliammeter or voltmeter.

The range of your milliammeter can be extended by adding a shunt across the meter terminals as shown in Fig. 1. The principle involved is simple. Suppose we have a meter with a basic movement of 0-10 milliamperes and we desire to extend its range to 100-Ma. In other words, with full scale deflection of the meter, we want 100-Ma. to flow through the shunt and meter combined. However, only 10-Ma. of the current should flow through the meter and the remaining 90-Ma. through the shunt.

CALCULATING METER SHUNTS

Since the current is inversely proportional to the resistance, the internal resistance of the meter should be 9 times that of the shunt. It will then conduct only 1/10 of the total current flowing. We can calculate the shunt value easily, if we know the meter's internal resistance. For example, if the meter has a resistance of 8 ohms, then the shunt should have 1/9 of this, or 0.88 ohm. This relationship between meter and shunt is expressed by Formula A, which can be used to calculate any value of shunt with any meter.

At first glance, the low values of resistance required appear difficult to construct without the aid of laboratory apparatus. This is not true—anyone can make these very accurately with some copper wire. As you know, copper wire has a small amount

of resistance per foot of length. The resistance for different gauges of wire can be found by referring to Table I. Find the length of the wire necessary by dividing the shunt resistance by the resistance per foot of length of the wire. The heavier the wire, the longer will be the shunt and less critical will be the cutting. Measure the wire, which should be drawn tightly but not stretched. Use this length of wire as your shunt. For convenience, wrap the wire around a thread spool or cardboard. The ends of the wire should be soldered to lugs that are fastened to the meter terminals.

A larger milliammeter (borrowed for the occasion) can be used as a standard to check the accuracy, in which case it should be connected in series with the meter to be tested. Otherwise, check it by allowing full scale current to flow by means of a potentiometer. Add the shunt. This causes the needle to swing back and read the value of the original current based on the new full scale range (see Fig. 2). Be careful not to burn out your meter.

A D.C. milliammeter may also be converted into a voltmeter. A voltmeter is simply a sensitive milliammeter in series with a high resistance.

Fig. 3 shows you the idea. Only fairly low-range meters can be used as voltmeters, for the amount of power wasted in a resistor rises very rapidly as the current increases. A 2-Ma. meter is about the largest that can profitably be used. Calculate the resistance necessary by using Formula B. Ordinary carbon resistors can be used, but for greatest accuracy these should be altered to obtain exact values. Choose a value of resistance slightly less than that required.

File away some of the carbon to bring the resistance up to correct value (the resistance varies inversely with cross-section area). Use the largest size obtainable (or several resistors in series) for safety. Insulate these sufficiently on the high-voltage ranges with friction tape or cambric tubing. Test the accuracy by comparing it with a manufactured voltmeter. When measuring unknown voltages, use the highest range to protect the instrument.

Always choose scales for voltmeters and milliammeters which are multiples of the original. This will eliminate calibration or marking of the meter dial.

All the principles discussed in this article
(Continued on page 509)

TABLE OF COPPER WIRE RESISTANCES

Gauge No. B. & S.	Ohms per 1000 ft. 25° C.	Gauge No. B. & S.	Ohms per 1000 ft. 25° C.
1	.1264	21	13.05
2	.1593	22	16.46
3	.2009	23	20.76
4	.2533	24	26.17
5	.3195	25	33.00
6	.4028	26	41.62
7	.5080	27	52.48
8	.6405	28	66.17
9	.8077	29	83.44
10	1.018	30	105.2
11	1.284	31	132.7
12	1.619	32	167.3
13	2.042	33	211.0
14	2.575	34	266.0
15	3.247	35	335.0
16	4.084	36	423.0
17	5.163	37	533.4
18	6.510	38	672.6
19	8.210	39	848.1
20	10.35	40	1069

Table I—Resistance vs. size of copper wire.

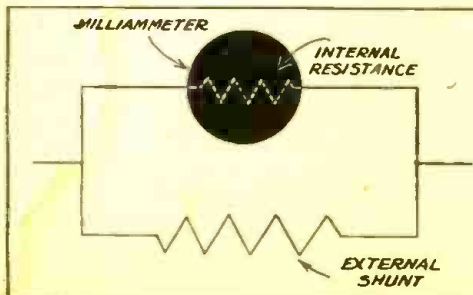

Fig. 1—Schematic of a milliammeter circuit.

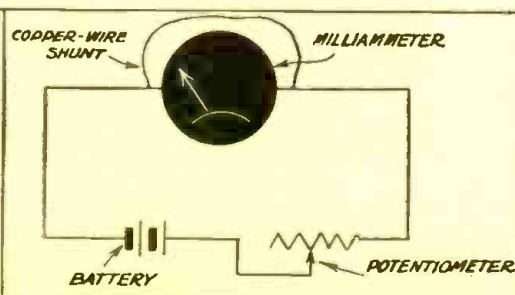

Fig. 2—Set-up for checking home-made shunts.

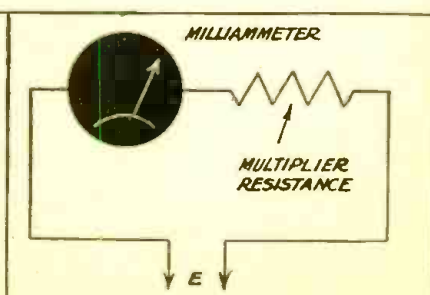

Fig. 3—This is all there is to a voltmeter.

Rare Tubes and Ohm's Law

By LUCY T. BRISEBOIS

ONE of the first and most valuable principles learned by radio men is Ohm's Law, which says, in effect: "The current is proportional to the voltage divided by the resistance."

If we know two of these factors, the third can be quickly calculated. It is very easy to shuffle the three factors from side to side in the equation until we have the unknown equal to the product or quotient of the other two.

Let's take a look at Fig. 1. This is a series combination of a battery and a resistor. If we know the values of the resistor and the battery, the current can easily be found.

Let's suppose the battery is a single flashlight cell and that the resistor has a value of 2000 ohms. To find the current we divide E by R, $1.5/2000 = .00075$ amps. (.75 ma.).

Similarly, we could start out with values for E and I. Suppose we wanted to draw 15 ma. from a 45-volt source. What value of resistance would we need? We know that $R = E/I$. Therefore, $45/.0015 = 3000$ ohms.

These examples show the usefulness of Ohm's Law. We often find similar applications in radio service work.

It is common practice in many receivers to connect the tube filaments in series. Fig. 2 shows such a circuit. Adding the voltage drops of each filament, we find the total voltage used, 62.6 volts. However, standard power lines usually provide 115 volts. The voltage difference, 52.4 volts, must be dropped in a resistor.

What value in ohms shall this resistor be? The calculation can be made without the slightest difficulty.

Referring to the circuit diagram, or to a tube manual, we first find the filament current, 0.3 amps. We have already found the voltage to be dropped. Therefore: $R = E/I = 52.4/0.3 = 174.5$ ohms. Ac-

tually, we would use a resistor of 175 ohms, as these are readily available commercially.

A pilot lamp is usually included in the circuit, such as the one in Fig. 3, which is typical. A portion of the voltage can be used to light this lamp. As the pilot lamp draws 0.15 amps. at 6 volts, its "hot" resistance is 40 ohms. To "bleed" an equal amount of current around the lamp, we would use a shunt resistor of equal value—40 ohms.

Wattage ratings are important. Let's see just how to calculate the wattage rating necessary for the bleeder resistor.

We know that the power used up in a resistance is equal to the voltage across it multiplied by the current through it, ($P = EI$). It may also be found by using two other convenient formulas: $P = I^2R$ and $P = E^2/R$.

In Fig. 3, the voltage dropping resistor R1 must consume 15 watts roughly. Therefore, we would choose a resistor rated at 30 watts. This conservative rating is necessary to prevent overheating of the resistor and circuit failure due to burned out parts.

This resistor must be so placed that it can radiate its heat without endangering delicate parts, such as coils or condensers, located near it in the receiver. For this purpose, a line cord is excellent. A ballast tube is also good, for it provides for heat loss on top of the chassis. It also provides an easy means of operating the pilot lamp.

Referring to Fig. 3, the power in the 6-volt, 40-ohm pilot lamp is .9 watts. ($6 \times .15 = .9$ watts). A shunting resistor rated at 2 watts would be suitable but a 5-watt resistor is best. It provides maximum protection in case of pilot lamp failure and passage of the entire .3 amps. series current through the shunt resistor alone.

Many of us have 35Z5 rectifiers with an open in the pilot lamp section of the tapped filament. The tube can be retained in service by making a direct connection between pins 2 and 3, which short-circuits the open section of the filament and restores filament circuit continuity.

Clearly, this does not permit the use of the pilot lamp. However, by connecting a 30-ohm, 2-watt resistor across pin terminals 2 and 3, operation can be secured. This resistor is in parallel with the pilot lamp and provides the necessary shunt resistance and current flow.

Many battery operated radios use 1.4 volt tubes. In Fig. 4-a the four tubes require 5.6 volts at .05 amps. It is unnecessary to worry about dissipating the remaining 0.4 volts as this amount is too little to cause any damage.

However, if the tubes were connected in parallel as in Fig. 4-b, a different situation would exist. Only 1.4 volts of the available 6 volts would be needed and the current drain would be 0.2 amps. To use up the 4.6 volts remaining, a 25-ohm, (approximate value), resistor would be needed. That is, $R = E/I$ and $4.6/0.2 = 23$ ohms. As the resistor would have to dissipate about one watt of power, $P = EI = 4.6 \times 0.2 = .9$, we would choose one rated at two watts for safety.

Occasionally it is necessary to substitute a 1C7 tube in place of a 1A7 tube because of tube shortages. The 1C7 type requires 2 volts at 0.12 ampere for the filament. The 1A7 requires only 1.4 volts at 0.05 amps. Fig. 7 shows a series-parallel circuit that can be used to accomplish our purpose.

The first problem is to drop the source voltage to the value needed by the 1C7 tube. This is done by means of resistor R1. Since the resistor must drop 4 volts and pass 0.27 amps., 0.12 for the 1C7 and 0.15 for the other 3 tubes, its value is $R = E/I = 4/.27 = 14.7$ ohms. A two-watt resistor is satisfactory since the power dissipated is about 1 watt.

Next, we must drop the voltage for the other three tubes. This resistor will have to drop 6 volts and pass 0.15 amps. By applying Ohm's Law, we find resistor R2 must have a value of 4 ohms. The power dissipated in the resistor is $P = EI = .6 \times .15 = .09$. A half watt resistor would serve.

The preceding examples have shown the utility of Ohm's Law. Merely by examining the filament circuits of several radio receivers we find numerous places where it can be used to advantage. Many other examples can be found by examining other parts of the receiver.

Tubes for civilian use are expected to total 4,500,000 in the first quarter of 1944, according to recent WPB statements. A substantially greater number than has been released in the past is now being made available through WPB re-examination of military orders. It was found that many of these high-priority ratings were not of extreme urgency. As a consequence, a section of the tube industry's producing capacity is being devoted to supplying civilian needs.

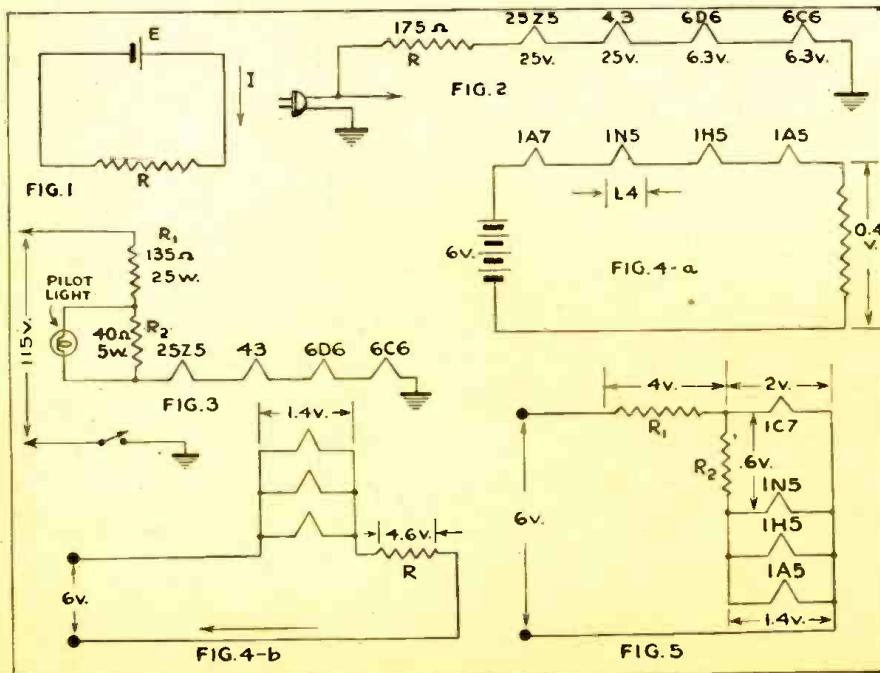

Electronic Multi-Checker

By CARL FISHBACK

As the war continues and more and more parts become scarce, the need often arises for a compact instrument to measure the value of those parts on hand. A good many experimenters do not possess the necessary meters to measure resistance and voltage, or to measure capacity and inductance. They may find this three-tube combination "magic-eye" vacuum tube voltmeter, ohmmeter and A.C.-D.C. voltmeter combined with an inductance and capacity indicator useful.

As any radioman will immediately see, the unit consists basically of a Wheatstone bridge with an electron ray tube as the indicator. The type 41 or similar pentode provides the control voltage for the eye while the type 80 rectifier provides the high voltage for the B circuit. A resistance capacity filter smoothes the pulsating D.C. from the rectifier.

As can be seen from the diagram, the unit has built-in standards for measuring most values of resistors, condensers, and chokes. A pair of pin-jacks are provided so that additional standards can be hooked in place of those in the unit and switched in or out at will.

In building the unit all leads must be as short as possible and the bridge part of the circuit must be wired with fairly large wire so as not to affect the measurements. The voltage and bridge measurements use a common ground jack. Switch A disconnects the bridge circuit from the vacuum tube voltmeter part of the circuit. As all condensers resonate at some frequency, and since the unit measures A.C. of a wide range of frequencies, it is necessary to use .001 condensers across the cathode by-pass and the final B filter condensers.

To calibrate the meter, proceed as follows: The center point of the dial may be marked 10. The 500-ohm point is marked 1, and the corresponding point on the opposite end of the potentiometer 100. If you set the standard resistor on 10,000 and check a 10,000-ohm, a 1,000-ohm and a 100,000-ohm resistor of known accuracy, these points can be located definitely. The same points will be 1,000, 100 and 10,000 ohms respectively on the 1,000-ohm scale, and so with all the others.

As these points fall on the same markings no matter which scale is used, all that is necessary is to measure as large a number of resistors as possible (say between 1,000 and 100,000 ohms) and mark down the points. Then a number of concentric circles can be drawn, and marked for the other standards.

Condensers work the same as resistors. If the 1 microfarad standard is used, point 10 will measure 1 microfarad. Point 1 will measure 0.1 mfd. and point 100 will measure 10 mfd.

Inductors also follow the same principle, but as all inductors have more or less resistance, the indications are not as reliable as in the case of resistors or condensers.

The voltmeter scale must be calibrated separately for A.C. and D.C. voltage. The 10,000 ohm potentiometer does not require setting once it has been set and the 50,000-ohm unit setting will determine the voltage

This simple instrument truly deserves to be named multichecker. Condensers, resistors, inductors and what have you (provided for by a special pair of terminals) can readily be measured without difficulty. Using the Wheatstone Bridge principle, the instrument is as accurate as the standards provided.

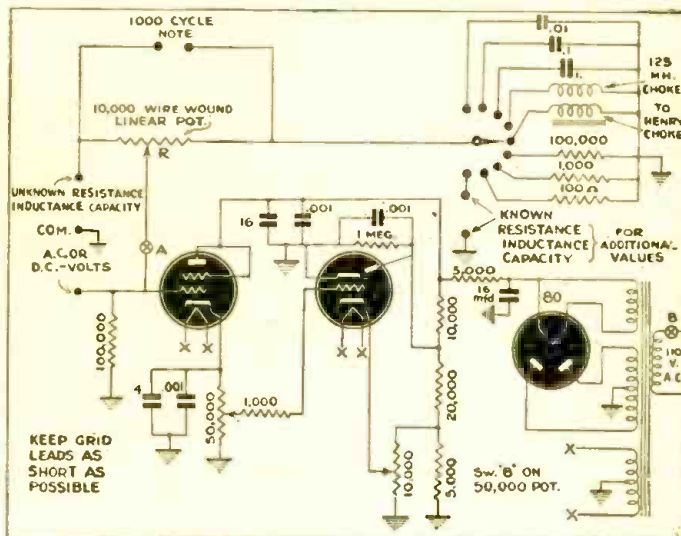

being measured. In other words, the potentiometer should be adjusted until the eye closes and this point of the dial marked to correspond with the known voltage being fed into the unit. The accuracy of the entire instrument will depend largely upon the care taken in calibration.

Long celluloid or plastic pointers may be used on the 10,000-ohm potentiometer in the bridge circuit and the 50,000-ohm one in the voltmeter circuit, so that a number of scales may be drawn under them. Both these potentiometers must, of course, be of the linear type if the scales are to be regular.

GRANDMA WORKS FOR VICTORY



With two sons, a son-in-law and a granddaughter serving their country in the armed forces, Mrs. Louise Oeser is engaged in speeding victory by calibrating radio transmitters at the General Electric Company, Schenectady, New York. The transmitters she works on are being made for the U. S. Signal Corps, thus indirectly for one of her sons, Richard, who is serving overseas as a lieutenant in the Signal Corps. Her other son, Robert, is a private in the U. S. Marine Air Corps; her son-in-law, Capt. J. R. Herron, formerly a G.E. worker, is stationed in the Hawaiian Islands, and his wife, Mrs. Oeser's daughter, is also employed in the radio transmitter section of G.E. Her granddaughter, who is 18, has just been accepted for the Army Nurse Corps and is in training at Plattsburgh.

World-Wide Station List

Edited by ELMER R. FULLER

A GERMAN operated station near 10.615 mcs. may be one of the old Rome, Italy, stations now located in Germany. It has been heard on Sundays at about 12:45 p.m. and as late as 9 p.m. The reception is very good. Another new German station may be heard around 5:30 p.m. on about 7.580 mcs.

An unknown station is being heard on 9.890 mcs. from 3:15 to 3:45 p.m. Both a man and a girl are heard talking during the broadcast, giving the news in ? language. Music is heard at times and the reception is very good.

A Polish clandestine is heard from 5:30 to 5:45 p.m. on 9.615 mcs. The announcer is a girl. The program consists mostly of talks with music now and then. If anyone has any information on this, please drop us a line. We desire more information on all

of these unknown stations which we have listed this month.

News in English may be heard from "Radio Bucaresti," Bucharest, Roumania, at 4:50 p.m. on 9.255 mcs. It is read by a girl announcer on most occasions. Reception is very good at times, with some fading.

Another unknown station is being heard on 7.560 mcs. at 5:45 p.m. with music and a girl vocalist. Another feminine announcer handles the mike for this station.

The twenty meter band is again coming through with a few of the South American hams being heard in the evening about 8 p.m. Signals are quite weak and have a bad fade on them. This is the first that they have been heard since last fall. Reports to us on their reception will be greatly appreciated.

Two newcomers to our station list are

KRO on 5.810 mcs. and KKH on 7.520 mcs. Both are located in Honolulu, Hawaii, and are heard in the morning around 8 a.m.

This month we have a complete revision of our own short-wave stations, with new frequencies and schedules. Please note them.

Reports for the past month have been received from Martin G. Redlich of Pullman, Washington; Burnell Thrasher of Missouri; Earle Grandison of Fairbanks, Alaska; Robert S. Duggan, Jr., of Georgia; Graham C. Whitehead of Saginaw, Michigan; Jerry Dyson of California; Frank Redding of Long Island; Bob Hoiermann of Ohio; Gilbert Harris of Massachusetts, and the Office of War Information of New York City.

All schedules below are Eastern War Time.

Mc.	Call	Location and Schedule	Mc.	Call	Location and Schedule	Mc.	Call	Location and Schedule
5.810	KRO	HONOLULU, HAWAII; news in English at 7:45 am.	9.590	WLWL	CINCINNATI, OHIO; West South American beam, 7 pm to midnight.	11.72	PRL8	RIO DE JANEIRO, BRAZIL; "Radio Nacional" nightly beamed to North America, 10 to 11 pm; off Sundays.
6.060	WCDA	NEW YORK CITY; Mexican beam, 7:30 pm to 2 am; European beam, 2:15 to 4 am.	9.650	WOOC	NEW YORK CITY; European beam, 3 to 7 pm.	11.725	JVW3	TOKYO, JAPAN; 9 am to 2:40 pm.
6.100	WKRD	NEW YORK CITY; European beam, 6:45 to 9:45 pm; 11:15 pm to 2:45 am.	9.905	---	DAKAR, FRENCH WEST AFRICA; heard 2:45 to 5 pm.	11.730	GVV	LONDON, ENGLAND; heard at 9 am and 12:45 pm to India.
6.120	WOOC	NEW YORK CITY; European beam, 7:15 pm to 2:45 am.	11.000	PLP	BANDOENG, JAVA NETHERLANDS INDIES.	11.730	WRUL	BOSTON, MASS.; Caribbean beam, 6:15 to 7:15 pm; Central American beam, 7:30 pm to 2 am; European beam, 2:45 to 6:00 pm.
6.130	JZH4	TOKYO, JAPAN; 11 am to 2:40 pm.	11.040	CSW6	LISBON, PORTUGAL; Brazilian beam, 6:45 to 8:45 pm.	11.730	WRUW	BOSTON, MASS.; European beam, 8 to 10 am.
6.140	WRUA	BOSTON, MASS.; North African beam, midnight to 2 am.	11.145	WCDA	NEW YORK CITY; European beam, 2 to 4 pm.	11.740	COCY	HAVANA, CUBA; 11 am to 1 pm.
6.170	WCDA	NEW YORK CITY; European beam, 5:15 to 7 pm.	11.410	---	"RADIO DAKAR"; FRENCH WEST AFRICA; 3 to 5 pm.	11.750	G5D	LONDON, ENGLAND; afternoons.
6.190	---	TOKYO, JAPAN; heard in the early morning.	11.535	DZA	BERLIN, GERMANY; afternoons.	11.77	DJD	BERLIN, GERMANY; North American beam, evening transmissions.
6.357	HRPI	SAN PEDRO SULA, HONDURAS; heard about 10:30 pm Sundays; may be on at other times.	11.6	---	ROUMANIAN FREEDOM STATION; 1:45 to 1:55 pm; 4:15 to 4:25 pm.	11.775	---	FRENCH INDO CHINA; "Radio Saigon"; 10 to 11:30 am.
7.250	WBOS	BOSTON, MASS.; East South America beam, 8:30 pm to midnight.	11.616	COK	HAVANA, CUBA; "The Voice of Liberty"; noon to midnight.	11.775	MTCY	HSINKING, MANCHURIA; 1:30 to 3 am.
7.435	FG8AH	POINTE A PITRE, GUADELOUPE; heard at 8:30 and 9:30 pm.	11.633	---	"HUNGARIAN NATIONS RADIO"; 1:15 to 1:27 pm; Sundays, 11:15 to 11:27 am.	11.78	GVU	LONDON, ENGLAND; North American beam, 6:30 to 7 pm.
7.520	KKH	HONOLULU, HAWAII; news at 8 am in English.	11.65	COCX	HAVANA, CUBA.	11.780	HP5G	PANAMA CITY, PANAMA; 9:45 pm to 7.
7.565	WKLJ	NEW YORK CITY; European beam, 8:15 pm to 5 am.	11.675	OPL	LEOPOLDVILLE, BELGIAN CONGO; 1 to 6:15 pm.	11.790	---	"RADIO PRAHEVA"; 11 to 11:08 am; noon to 12:07 pm; 1 to 1:07 pm; 2 to 2:07 pm; Talks about law and order during each transmission.
7.575	WRUA	BOSTON, MASS.; North African beam, 4:45 to 6 pm; 6:15 to 7:15 pm; 7:30 to 11:45 pm.	11.68	GRG	LONDON, ENGLAND; 6 to 7 pm.	11.790	WRUA	BOSTON, MASS.; North African beam, 6 to 7:30 am; 7:45 to 1:30 pm; 1:45 to 4:30 pm.
7.575	WLWO	CINCINNATI, OHIO; European beam, 12:15 to 2:30 am.	11.700	GBW	PANAMA CITY, PANAMA; news (English) 7:15 pm.	11.79	KGEI	SAN FRANCISCO CALIF.; 5 pm to 12:45 am; South American beam.
7.820	WOOW	NEW YORK CITY; European beam, 5:15 pm to 2:45 am.	11.705	SBP	LONDON, ENGLAND	11.80	JZJ	TOKYO, JAPAN; 11 pm to 4 am.
8.500	---	TOKYO, JAPAN; early morning transmissions.	11.705	CBFY	MOTALA, SWEDEN; on at 11 am.	11.800	HI3X	TRUJILLO, DOMINICAN REPUBLIC; testing in afternoons.
9.590	WCRC	NEW YORK CITY; European beam; 4 to 6:45 am.	11.710	WLWO	VERCHERES, CANADA; 11 am to noon.	11.805	COBH	HAVANA, CUBA; afternoons.
			11.720	CJRX	CINCINNATI, OHIO; European beam, 6:30 to 8 am; 2:45 to 5:15 pm.	11.81	2RO22	ROME, ITALY.
					11.820	G5N	LONDON, ENGLAND; after 10 am.	
					11.820	XEBR	HERMOSILLO, MEXICO; afternoons.	
					11.830	WCRC	NEW YORK CITY; West South America beam, 5:30 pm to midnight; European beam, 7 am to 5:15 pm.	
					11.840	COBH	HAVANA, CUBA; mornings, afternoons, and evenings.	
					11.847	WGEA	SCHENECTADY, NEW YORK; European beam, 6:15 am to 4:45 pm; Brazilian beam, 5 to 8:15 pm.	
					11.86	GSE	LONDON, ENGLAND; 10:15 am.	
					11.870	WBOS	BOSTON, MASS.; European beam, 5:45 to 7 am; 3:15 to 5:15 pm.	
					11.870	WOOW	NEW YORK CITY; European beam, 7 am to 2:45 pm.	
					11.870	WN8I	NEW YORK CITY; East South America beam, 7 pm to midnight; Sundays only, 7:45 pm to midnight.	
					11.88	LRR	ROSARIO, ARGENTINA; heard evenings; CBS news in Spanish, 6:30 to 6:45 pm.	
					11.893	WRCA	NEW YORK CITY; European beam, 5 to 8:45 am; 3 to 4:45 pm.	
					11.895	GXA10	MONTEVIDEO, URUGUAY; "Radio Electrica de Montevideo"; heard evenings, about 7:30 pm.	

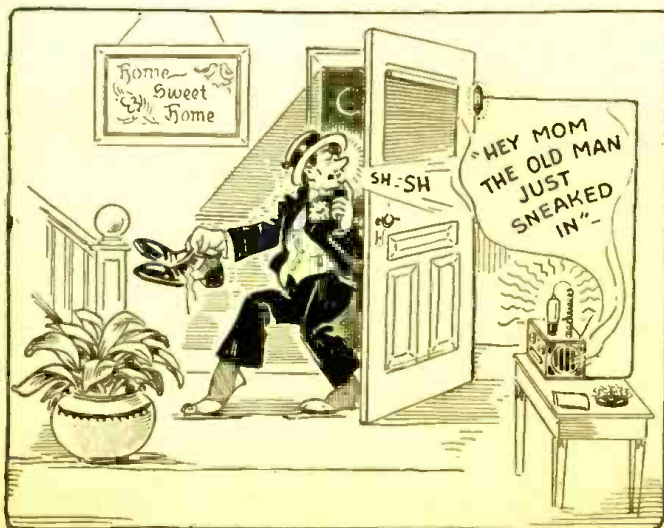

Suggested by:
CLARENCE DOTTA
Seaside, Calif.

(Continued on page 494)

YOUR MONEY BACK IN 5 DAYS

IF Ghirardi's big 972 page **RADIO PHYSICS COURSE** doesn't teach you **RADIO-ELECTRONIC** fundamentals **FASTER** and at **LESS COST** than any other book or course!



A. A. GHIRARDI
Radio's most widely read Author

THE MOST WIDELY USED TRAINING BOOK OF ITS KIND IN THE WORLD

Here, in a single, big 972 - page volume, is a miracle of modern Radio-Electronic Training—sold at a small fraction of the price you might expect to pay—and backed with a 5-DAY

MONEY-BACK GUARANTEE that makes you the sole judge of whether or not you want to keep it. *You cannot lose!*

NO PREVIOUS TRAINING REQUIRED

Everything that can be done to make learning Radio easy for you at home has been done in Ghirardi's **RADIO PHYSICS COURSE**. No previous training is required. All you need is a little spare reading time—and a desire to get started **RIGHT** for a profitable, interesting future in any of Radio's many branches, from Radio and Electronic Servicing, to Aviation, Military, Broadcasting, Manufacturing, Public Address, and many others. There is no guesswork when you buy Ghirardi's famous **RADIO PHYSICS COURSE**. You **KNOW** you'll get complete, time-tested Radio-Electronic training and get it right **BECAUSE:**

1. *This same inexpensive book has given more people their basic training than any other ever published.*

2. *It is more widely endorsed and recommended by men already in Radio.*
3. *It is more universally used for home study, and more widely used in more U. S. Army Signal Corps, Navy and civilian schools and colleges than any other.*

Would you want any better proof?

What other books and courses skim over, **RADIO PHYSICS COURSE** painstakingly explains in detail so that you cannot fail to understand clearly. It even contains over 300 pages devoted to the all-essential foundation knowledge of Electricity without which no Radio Training could possibly be complete or understandable.

MORE TRAINING FOR YOUR MONEY

Such features are highly important. They explain why thousands of civilians and men in the armed forces report that **RADIO PHYSICS COURSE** makes the study of Radio-Electronics easier, more interesting, and more genuinely helpful to them than any other book or course they've ever seen. Actually, this famous volume gives you the scope of 36 different courses in one—packed into an easy-to-follow 972-page book with 508 clear illustrations, and 856 self-testing review questions—all for the price of only \$5 complete (\$5.50 foreign). Send for it today!

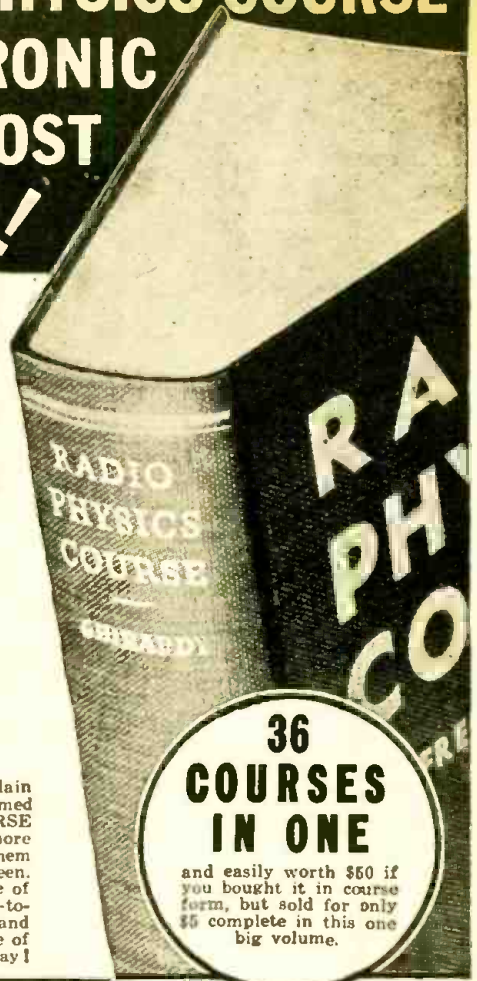

36 COURSES IN ONE
and easily worth \$50 if you bought it in course form, but sold for only \$5 complete in this one big volume.

NEW! Ghirardi's Wartime Guide for **DIAGNOSING, LOCATING AND REPAIRING RADIO RECEIVER TROUBLES**

(**RADIO TROUBLESHOOTERS' HANDBOOK**—Now in its 3rd Revised Edition)

Stop guessing on radio service jobs—stop wasting time **THAT ACTUALLY COSTS YOU MONEY!**... Here is the most important book any repair shop or individual can own during these war shortage days! Enables you to cut corners on jobs—cut troubleshooting and repair time **IN HALF**—train new helpers—repair cheap sets at a real profit—substitute available tubes and parts properly—

handle tough jobs in half the usual time—and much more.

COVERS 75 VITAL SUBJECTS

This new 3d, Special Wartime Edition of Ghirardi's popular **RADIO TROUBLESHOOTERS' MANUAL** has been completely revised, greatly enlarged, and contains nine entirely new and additional sections of vital new material—including the finest, most up-to-the-minute tube chart you've ever seen.

Its 404-page Case History Compilation gives common trouble symptoms (their Causes and Remedies), for over 4,800 models of the 202 most popular makes of receivers—and that is just the beginning of the book's usefulness. 74 other big subjects include all the various kinds of information you need to help you repair more radios in less time and at better profit to you. Sold for only \$5 complete (\$5.50 foreign) on a 5-DAY **MONEY-BACK GUARANTEE**. Folder free.

WORK TWICE AS FAST!

GHIRARDI'S FAMOUS **MODERN RADIO SERVICING**

Another indispensable volume by Radio's best known technical author is Ghirardi's **MODERN RADIO SERVICING**—the only single text book covering modern radio testing instruments, troubleshooting, and repair procedure **COMPLETELY**. Actually it is a 1300-page homestudy course on the entire art of Radio repair, complete with 706 illustrations, and 720 self-testing review questions. Sold for only \$5 complete (\$5.50 foreign).



See Money-Saving Combination Offer in Coupon!

THE 3 GREATEST VALUES IN MODERN RADIO-TRAINING

RADIO & TECHNICAL DIVISION OF MURRAY HILL BOOKS, INC.
Dept. RC-54, 232 Madison Ave., New York 16, N. Y.

- Enclosed find.....in payment for books checked below; or
- Send C.O.D. (in U.S.A. only) for this amount plus postage. In either case, if I am not fully satisfied, I may return the books at the end of 5 days **AND RECEIVE MY MONEY BACK.**
- Ghirardi's **RADIO PHYSICS COURSE** \$5.00 (\$5.50 foreign)
- NEW 3rd Revised Edition of RADIO TROUBLESHOOTER'S MANUAL** \$5.00 (\$5.50 foreign)
- MODERN RADIO SERVICING** \$5.00 (\$5.50 foreign)

MONEY-SAVING COMBINATION OFFER

Troubleshooters' Handbook and Modern Radio Servicing at a special price of only \$9.50. **FOR THE TWO** (\$10.50 foreign).

Name
Address
City State

REPAIR ANY MAKE OF RADIO EQUIPMENT!

Prepare Now for a Good-Paying Job in the Radio-Electronic Field

New Radio-Electronic Devices

D. C. AIRCRAFT MOTOR

Alliance Mfg. Co.
Alliance, Ohio

PRIMARILY designed to operate blowers for cooling purposes in aircraft equipment, the unit operates on 28 volt D.C. source at 0.75 amperes delivering a full 1/80 H.P. at 8000 R.P.M. The motor is of the latest approved aircraft design of light weight and high efficiency consistent with sturdy, totally enclosed, ball bearing construction. It measures overall less than 1/4 inch diameter shaft extension, 3 inches in length by 1 7/8 inches diameter and weighs but 17 ounces. Low temperature rise permits operation under high ambient temperatures.

This basic design can readily be modified to meet other volume applications with either shunt or series winding for desired voltage, current drain and horsepower output up to 1/50 consistent with speed and duty cycle.—*Radio-Craft*

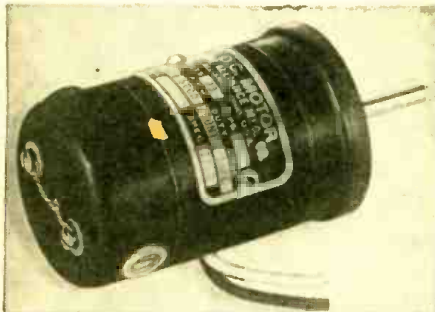

ELECTRONIC VOLTMETER

Alfred Barber Laboratories
Flushing, N. Y.

A NEW probe designed for greater convenience and efficiency especially at high frequencies such as those encountered in frequency modulation and television design and test work is a feature of this Wide Range Vacuum Tube Voltmeter. This probe is cone shaped with the "high" terminal in its nose. This permits extremely close connection to be made to the circuit under test, which is very important at high frequencies. The probe is molded from low-loss material thereby reducing loading on the circuit under test to a minimum.



Vacuum Tube Voltmeter Model VM-27E is shown with its probe connected to the input circuit of an experimental frequency modulation receiver. The probe being attached to a four-foot cable permits the voltmeter proper to be placed in the most convenient position on the test bench. The large meter may be easily read even at a

distance. Simplified controls and stable operation make the Model VM-27E Vacuum Tube Voltmeter an extremely useful instrument even in the hands of inexperienced operators.

The Model VM-27E Vacuum Tube Voltmeter measures voltages from 0.1 to 100 volts at D.C., A.C. and R.F. frequencies to over 100 megacycles.—*Radio-Craft*

FLUXED WIRE SOLDER

National Lead Co.
New York, N. Y.

A NEW type of fluxed wire solder, which contains flux in longitudinal grooves on the surface rather than in the conventional core, represents, according to the manufacturer, the first basic improvement in fluxed wire solder design since the introduction of this type of material a number of years ago.

The new material is said to overcome completely an inherent disadvantage of regular cored solders which supply flux and solder to the surface simultaneously. Since the flux in the new product is outside rather than inside, it liquefies and flows onto the work before the solder melts. This insures thorough and complete fluxing and results in stronger and better solder joints. Quicker work is a second advantage.

In addition to pre-fluxing, the new solder also is said to guarantee an unbroken flow of flux. Interruptions in the flow sometimes occur with cored solders due to gaps or voids in the flux core. Since the new product has more than one flux-filled groove, there is a continuous flow at all times.

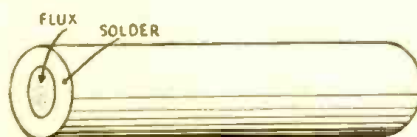

CONVENTIONAL FLUX-CORE WIRE SOLDER

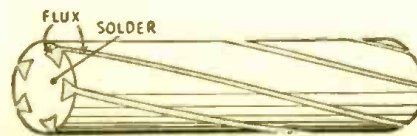

NEW TYPE OF WIRE SOLDER WITH FLUX IN GROOVES

An additional advantage claimed comes from the fact that the flux supply being outside the wire, is always visible to the user and can be checked quickly and readily. Gaps or voids in ordinary cored solders are not detectable until after soldering begins. Uniform fluxing is thus assured.

The new product, which contains a recently developed special flux, comes in the same diameters as regular cored solder. It is available in two compositions designated as Red Stripe and Green Stripe. These designations refer to the color of the flux which has been specially dyed in each case for easy identification. Thus the right solder may be applied to any given job without hesitation or chance for mistake.—*Radio-Craft*

"COPROX" RECTIFIERS

Bradley Laboratories, Inc.
New Haven, Conn.

GOLD contacts on the copper oxide "pellets," highly adaptable mountings, pre-soldered lead wires, and other arrangements to prevent overheating during assembly of equipment using these rectifiers, are innovations. BX-100, a center tapped, full wave rectifier, is completely enclosed in Bakelite and rectifies high frequency current, operating in special circuits up to 8 megacycles. BX-22.3 is a double bridge



BX-22.3



BX-100

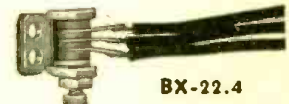

BX-22.4

rectifier, with excellent temperature and temperature-current characteristics. BX-22.5 is a single half-wave rectifier, BX-22.2 a full wave, and BX-22.4 a double half-wave. Conservative ratings show very low forward resistance, combined with high leakage resistance.—*Radio-Craft*

REGULATED POWER SUPPLY

Radio-Television Institute
480 Lexington Ave., New York, N. Y.

THE unit is designated as Model 44 and its D.C. output is continuously variable from 0 to 300 volts. At settings toward the upper end of this range the voltage changes less than 0.2 volts when 100 milliamperes load is applied. At low voltages the voltage variation with 100 milliamperes load is less than 0.1 volts. Maximum output voltage change with line variations of 105 to 125 volts varies from 0.15 volts at the low end to 0.5 volts at the high end.

Output voltage is set by a single knob in addition to the 3-position range-changing switch. A voltmeter is incorporated in the instrument.

In addition to the Model 44, there is also available Model 42-A, which delivers 1.0 to 1.5 volts D.C. at 500 milliamperes. This unit is suitable for a filament supply in production-testing of equipment using battery type tubes. Hum content is specified at less than 2 milli-volts.

A third model will soon be available delivering 45 volts at 40 milliamperes. This regulated supply will have approximately the same size and weight as the standard "B" battery.—*Radio-Craft*

SPRAGUE TRADING POST



A FREE Buy-Exchange-Sell Service for Radio Men

IMPORTANT NOTICE!

We discourage offers to buy or sell anything beyond the O.P.A. ceiling prices, and will not knowingly accept such ads for the Sprague Trading Post.

FOR SALE—Readrite 432 tube checker, \$18.50; Superior channel analyzer, \$21.50; Hi-rate Homcharger (6-V. Bat. charger), \$10. Charger needs new vibrating springs & points. Steinmetz Radio-Electric Shop, Chandler, Ind.

FOR SALE—All new: Jensen M-20, \$45; Jensen M-18 A.C. model Q tweeter, filter & controls in BR cab., \$200; 1 Garrard magnetic pickup \$7.50; Racine Web. max., \$4.50; Amertran D-51 interstage, \$12; Amertran No. 710, \$8; Amertran D-11, \$8; UTC UH6 power, \$7.50; two C8301 chokes, \$4 ea.; Thordarson T58872, \$4; T17C00, \$2.95; T18C30, \$2.25; T67C46, \$1.00; T93C30, \$2.90; T74C30, \$1.65; T15C54, \$6.25; T37C38, \$9.25; T14C70, \$3; C-B model UDR power level meter, relay rack mtd. \$40; two Par-Metal 8 1/2 x 19 x 3/16 slum. Panels, \$3 ea. Lots of other PA and radio eqpt., used tubes, etc. Send for list. Herman McMasters, 1800 So. 26th St., Terre Haute, Ind.

WANTED by World War II veteran, a tube tester—reliable make to handle recent tubes. M. L. Halprin, 6577 York Rd., Philadelphia 41, Pa.

WANTED—Portable radio, preferably one with self-charging storage battery. A/C Bob Vaughn, Class 44-H, Darr Aero Tech, Albany, Ga.

WILL TRADE—1-6A7; 1-12SQ7; 1-6SL7; 1-6CS; 1-1H4; 2-6SK7; 1-5Y4; and 8F5 tubes (all new) for: 1-50L6; 1-4Z25 or 8Z25; 1-12S47; 1-12SK7, J. S. Martin, Room 24, YMCA, Danville, Va.

WANTED—Superior 1230 Sig. generator or equivalent. J. E. Forrester, 1407 Montana St., San Antonio 3, Texas.

EPT. FOR SALE—4 rim drive phono motors and 2 crystal pickups, 4 extra cartidges, \$25; 15 transformers used but A-1, outputs, interstage power, chokes, etc., \$15; new Reeco 500 ohm cutting head, \$6.75; RCA broadcast pickup with trans. arm, \$11; 2 W-E 24 jack patch panels, \$15; 80 tubes mostly new, all A-1, no cartons, \$15; Wurlitzer 816 amplifier, needs condenser \$15. Other hard to get parts. Lifetone Sound Labs, 2000 Peoria Ave., Peoria, Ill.

TUBES WANTED—35L6; 50L6; 17Z6; 12SQ7. Cash. Apple's Radio Rep. Shop, 220 Monroe St., Lonoke, Ark.

FOR SALE—or will trade, 5 AmPion P.A. horns, 6' x 3' x 2' and slightly smaller without units. Nicholayoff, 22 W. 22nd St., New York 10, N. Y.

FOR SALE—Hickok AC-51 modernized tube tester, out of calibration, ask for details. Gernsbaeks Vols. 1 and 2 diagrams in one vol. like new; Grebe SK-4 audio amplifier with 12" speaker compl. with tubes. Blackford Radio Service, Broadhead, Wis.

FOR SALE—3 mikes and cords, 1 turntable in case use with 6-V. ampl., 1 battery 1 1/2 VA-90V-B No. 17GD60 Burgess. 3 and 4-wire cord for speakers, etc. A. L. Heintz, Minster, Ohio.

FOR SALE—Supremo 85-C tube tester in A-1 condition. C. G. Thompson, 1707 Ave. J, Lubbock, Texas.

FOR SALE—SX-24 Hallcrafters comm. receiver and matching speaker. A-1 condition. E. J. Sainey, 840 Pleasantville Rd., Lancaster, Ohio.

FOR SALE—Rider's vol. 7 like new, \$9; Hickok T-53 port. tube tester A-1 condition, \$40. E. S. Dawson, 1201 N. 5th St., St. Charles, Mo.

WANTED—Readrite Ranger pocket-size tester. Edward W. Nash, 2 Glenville Ave., Brantford, Ont., Canada.

URGENTLY NEEDED—Small size or pocket ac-de V-O-M; also tube tester or comb. V-O-M and tube tester. Cash. Wm. Troup, Fort Stanton, N.M.

WANTED—Rider Manuals Nos. 1 and 2. M. Cutter, 802 No. Camden Drive, Beverly Hills, Calif.

FOR SALE—Abbott TR-4 & battery-operated power supply, both new. Need National 1-10 receiver. Rice, 2011 West Court St., Filing 8, Mich.

WANTED—Multitester tube tester and sig. generator, Simpson or RCA preferred. E. L. Crisman, 1126 Leavitt St., Waterloo, Iowa.

WANTED—Supreme 562 audiolizer or Carron CCH sig. tracing amplifier. Fincher-Todd Radio Service, 1211 University Ave., Tuscaloosa, Ala.

WANTED—Late model tube checker and V-O-M or combination. Monroe Hibbs, 801 Princeton St., Providence, Ky.

FOR SALE—Over 300 radio magazines, 15 different kinds. Write. Col. Edwin Froom, Co. F, 847 Sig. Trnk. Bn., Camp Crowder, Mo.

WANTED—Two A12 PM Jensen speakers, 15-w., new. Also one coil winding machine, hand or electric, that will splice wire for small radio coils. Describe. W. P. Haughton, 8929A Rutger St., St. Louis 4, Mo.

FOR SALE—Two Webber tube testers, A-1 condition. One No. 30 portable in wood cabinet; one No. 60 in metal cabinet for counter use. Pyle Electric Service, Chappell, Neb.

FOR SALE—Janette Rotary Converter, 110-V. d.c. to 110-V. a.c. 500-watt, \$40; 175-watt, \$22. A-1 condition. Ted Schoon, Laverne, Minn.

WANTED TO BUY a complete radio service business. Give number & type of instruments, and estimation of parts stock. Elzie A. Conner, Route No. 3, Stamford, Texas.

WANTED—National 1-10, Hallcrafters S-27, or any good VHF receiver. Type 815, 9002, or 9003 tubes. M. L. Myers, Box 665, Portsmouth, Ohio.

TUBES WANTED—New or good used: 12SA7; 12SK7; 1A7; 1E5; 50L6. Pay ceiling prices. Bender Repair Shop, Box 455, Sealy, Texas.

WANTED—One No. 47 tube. Cash. Ferdinand Zirbel, Chasleey, N. Dak.

WANTED—Small multi-test meter, must test d-c volts, ohms, possibly also a.c. volts. R. L. Heaton, 127 Wesleyan Ave., Apopka, R. 1.

FOR SALE—JFM 90 GE FM translator in original carton, \$30. Jouret's, 220 S. 4th St., Jeannette, Pa.

FOR SALE—1 Jewell and 1 Burton-Rogers tube checkers. Instruments are obsolete but meters A-1 condition and will serve to make two good d-c milliammeters, \$10 each. Earl R. Moutz, 2901 Filbert Ave., Pennside, Reading, Pa.

FOR SALE—Ten tape-operated code machines: 1 visual output indicator; 3 AC-DO volts, ohms, capacity measuring instruments; 6 photo enlarger meters, Walter Wescoat, Box 92, R.R. No. 1, Hammoncton, New Jersey.

WANTED—Tube and set tester, or V-O-M or any kind of radio test instruments. Cash. F. E. Bergen, 915 W. First St., Florence, Colo.

WILL SWAP—Have: Sterling No. 14 tube tester and Dayrad No. 14 tube tester; galvanometer; All-American battery eliminator; D-C milliammeter model 221, range 0-1. In good condition. Want a signal tracer. Frank J. Nilfong, Warrenton, Mo.

WANTED—2" cathode ray tube, also V-O-M or 0-1 D.C. M-A meter. Robert P. McCabe, 1470 Boscobel Ave., New York 53, N. Y.

URGENTLY NEEDED—Good V-O-M or V-O-M tube tester combination. Sct. C. L. Stalling, Btry. A, 585th AAA Bn., Camp Hulen, Texas.

WANTED—RCA 3" oscilloscope; C-B audio oscillator; Cnaudagraph SU 18-12 speaker. Have for sale: hard-to-get tubes, old and new types; various dynamic speakers, Western Auto model D-1180 batt. AC portable; power trans.; chokes, etc., etc. Write. Horace D. Westbrook, 124 M St. S.W., Thomaston, Ga.

WANTED—Used sig. generator. Prefer Canadian answers. Others acceptable. Bill Gordon, Box 42, Oxbow, Sask., Canada.

WANTED—Any available radio service data manuals. Describe fully. Albert Barrows, Oxbow, Sask., Canada.

WANTED—Tube tester, analyzer, sig. generator, new or used tubes, and service tools. What have you? Dwight Lindley, R. No. 3, Liberty, N. C.

WANTED—0-1 ma. meter, any make, 2" size preferred but must be A-1 and have 5% accuracy or better. Also 6ES. Will sell Universal mike model W. new. Crystal with holder approx. 1850 kc. E. Koputios, Three Hills, Alberta, Canada.

FOR SALE—500-W 2000-V 1750 r.p.m. D-C generator used for radio emitting eqpt. Can be arranged for direct-connected to AC motor if desired, price \$65. Will trade for small lighting plant or motors. A. J. Ruel, 245 Citrus Ave., Dunedin, Fla.

WANTED—Radio tubes: 3A8; 12SF7; 11T7; 35Z5; 50L6; 12SK7; 12SA7; 3Q5; 1H5; 1N8; 1P5; 1A7; 5Y3. Also want A.C.-D.C. V-O-M with 1000 ohms per volt. V. J. Balcar, 506 W. 44th St., Austin 22, Texas.

URGENTLY NEEDED—V-O-M in good cond. Will pay \$30 for RCA voltohyst jr. Chas. Kuhns, Rt. 1, Box 2038, La Mesa, Calif.

SPRAGUE VICTORY-LINE CAPACITORS

HOW TO SUBSTITUTE CAPACITATORS Accurately

Besides listing the "Victory type" Sprague Atom Electrolytics and TC Tubulars for wartime service use, this folder contains helpful information on making these 18 Capacitor types do the work of the 473 capacitors normally included in our catalog. Send a post card today for your copy.

FOR SALE—Teleplex code inst. machine, A.C.-D.C. send-receive audio oscillator, leatherette carrying case, special tapes, excellent condition. \$35. L. Carini, 248 Wocott Hill Road, Wethersfield 9, Conn.

WANTED—One 12-15 watt speaker with p-p output trans. State impedance of trans. Primary. Also want two 6V6's, metal or glass, and one 68C7. What do you need? W. O. Jacobson, 1109 Johnstone St., Sault Ste. Marie, Mich.

FOR SALE—Weston tube tester, No. 670, in A-1 condition, \$25; Supreme tube tester, No. 35, in oak case, good condition, \$15. Also offer the following tubes: 2-58; 1-01A; 7-199; 2-6Y5; 5-39; 6-38; 6-Q25; 4-645; 3-89; 7-6E7; 6-6C7; 6-6D7; 1-BH; 12-24A; 1-26; 4-38; 1 Gamatron 54. Alois T. Goutz, 1007 Parnell, Sault Ste Marie, Mich.

FOR SALE—5 speakers without cones; 3 power trans. 1 25 cycle; 2 iron core chokes; asst. of r-f, a-f, and i-f coils; small asst. mica, paper, and elec. condensers; resistors & voltage dividers; 4 tuning condensers and one ea. of following tubes: 25A3; 80; 38; V-1; 7C6; 6C6; 6E73; 12K7; 2-6N7; 25Z5; 25L6; 35L6; 35Z5; some new. Want to sell entire lot. Frederick C. Burdick, Murray Hill, Mt. Morris, N. Y.

FOR SALE—No. 411 Radio City V-O-M. \$15. James Langham, 2418 Harney Ct., San Diego 10, Calif.

WANTED—Astatic B10 crystal pickup, or Audak magnetic pickup. Also need RCA Viscoid damped magnetic pickup. Cash. M. R. Marston, 1414 Glenwood Blvd., Schenectady, N. Y.

YOUR OWN AD RUN FREE!

This is Sprague's special wartime advertising service to help radio men get needed parts and equipment, or dispose of radio materials they do not need. Send your ad today. Write PLAINLY—hold it to 40 words or less. Due to the large number received, ads may be delayed a month or two, but will be published as rapidly as possible. We'll do everything we can to help you—and the fact that thousands of pieces of Radio-Electronic equipment are in operation today as a result of sales or "swaps"

made through The Trading Post offer convincing proof of the far-reaching effectiveness of this service.

Different Trading Post ads appear monthly in Radio Retailing Today, Radio Service-Dealer, Service, Radio News, and Radio Craft. Sprague reserves the right to reject ads which do not fit in with the spirit of this service.

HARRY KALKER
Sales Manager

When buying Capacitors—please ask for Sprague's by name. We'll appreciate it!

SPRAGUE PRODUCTS CO., DEPT. RC-45 North Adams, Mass.

SPRAGUE CONDENSERS KOOLOHM RESISTORS

Obviously, Sprague cannot assume any responsibility, or guarantee goods, services, etc., which might be exchanged through the above advertisements

THE QUESTION BOX

MIKE PRE-AMPLIFIER

? I would like to have a diagram of a single-stage pre-amplifier that I can use as an extra channel on my Wilcox-Gay A85-A87. I would like to use this on all positions of the radio-record switch.—D.F.H., Hartford, Conn.

A. This pre-amplifier follows the circuit of the microphone amplifier tube already in your set. By attaching the output lead to the top or hot end of the volume control, it may be used in practically any receiver. In many sets, it will be sufficient to plug it into the phono input.

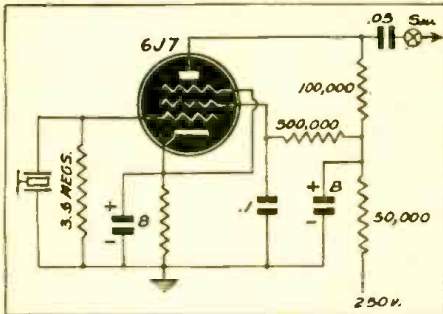

All power for the pre-amplifier may be drawn from the receiver, and the ground may be made to the receiver chassis.

REVAMPING FOR '50'S

? I have an amplifier which uses a 6N7 to drive a pair of 6F6's, somewhat in the manner of the Australian Champion.

I would like to replace the 6F6's, which are needed for other purposes, with '50's, of which I have a number. Will any changes be necessary?—H. S. B. B., Negritos, Peru.

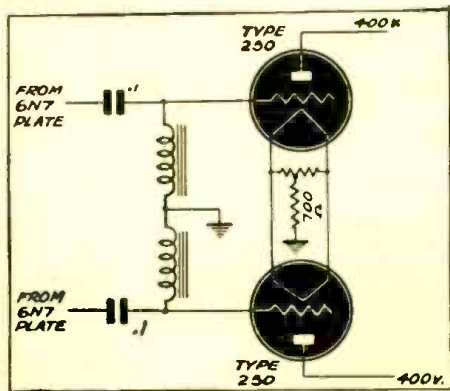

A. The '50 tube cannot be used in a circuit which has a grid-leak resistor, such as the 100,000 ohms in the 10-12 watt amplifier or the 250,000 in the Australian champion. The grid-circuit impedance must be kept low. The diagram sketched indicates how that difficulty may be surmounted. Two chokes are used instead of grid-leaks. These may be secondaries of audio transformers, or any other small choke of extremely high inductance.

For best results, the '50's should have a plate supply of 400 or 450 volts.

All queries should be accompanied by a fee of 50c to cover research involved. If a schematic or diagram is wanted, please send 75c, to cover circuits up to five tubes; over five tubes, \$1.00.

Send the fullest possible details. Give names and MODEL NUMBERS. Include schematics whenever you have such. Serial numbers of radios are useless as a means of identification.

All letters must be signed and carry FULL ADDRESS. Queries will be answered by mail, and those of general interest reprinted here. Do not use postcards—postmarks often make them illegible.

No picture diagrams can be supplied. Back issues 1943, 25c each; 1942, 30c each; 1941, 35c each, 1940 and earlier, if in stock, 50c per copy.

AN INTERESTING QUERY

? I have an old radio that I patched up some years ago, and as radio parts and tubes are so hard to get, I am using this old set. It works but it has a bad hum so I am now inclined to think some resistor or something is where it should not be.

I do not recall the output of the parts such as the transformer, but it uses a 57 tube, 1-2A5, 1-80 and 1-58.

Can you furnish me with a hook-up so as to make this set operate properly?

I have some of your radio books but I don't seem to find any hook-up that employs these four tubes.—T.G.S., North Dakota.

A. Here is a splendid example of how an inquiry should not be written. No mention of the name of the radio, or whether a

home-made set, is made. No indication of the type of hum, whether heard equally at high and low volume, at the point of regeneration (if the set is regenerative, which he does not state). This question cannot be answered in its present state. What is required is the name and model number of the set. If home-built, a schematic (drawn on a decent-sized piece of paper) will do. All possible information on the symptoms is also helpful, as certain hums, for example, are identified with the power supply and appear at all times, while others may appear only when the set is at the point of regeneration. Servicing a radio by remote control is a guessing game at best—Dunninger could not do it from letters such as these!!

POWER OUTPUT STAGE

? Will you please print me a diagram for an amplifier output stage using four 6A3's in push-pull parallel? — R.N.B., New Orleans, La.

A. The circuit is shown here. With about 300 volts on the plate and a low-impedance input transformer, this should give an output of more than 30 watts, and can be pushed up further than that. The resistance of the choke should be kept low, and a power transformer with ample current rating used. The 2A3's draw 60 Ma. each, so the minimum transformer and choke ratings should be 250 to 300 Ma. The resistors in the plate circuit tend to stabilize the circuit. Input impedance should be low, transformer coupling being the best. The impedance circuit shown at the left also works well.

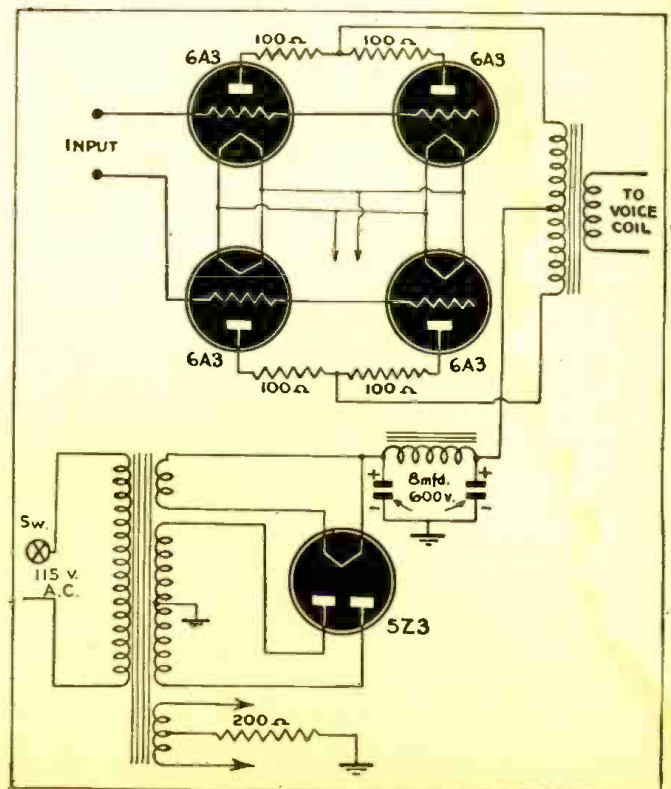

WILEY BOOKS

That Will Shape Your Future in the Field of COMMUNICATIONS — ELECTRONICS



Now is the time for you to get ready for bigger jobs — bigger pay in the field of **COMMUNICATIONS—ELECTRONICS**. Remember, post-war plans are being made now, and your future depends upon how much you know about the latest developments in this field. Look over the books listed below, make your selection and be prepared.

How to Pass RADIO LICENSE EXAMINATIONS

By C. E. DREW

Newly revised and brought up to date, this well-known book in question-and-answer form gives you complete preparation for the F.C.C. tests. It contains answers to 1300 questions found in the F.C.C. Study Guide. Furthermore, it explains the answers so that you thoroughly understand each. The information is divided into six sections and contains new material on frequency modulation, oscillators, classes of amplifiers, rectifiers, power supplies and the like. If you're an amateur radio operator, a radiotelephone or telegraph operator—or if you are interested in broadcasting, or in marine, aeronautical or any other field of radio transmission or reception, this book will give you the best available preparation for the government examinations.

Second Edition 320 Pages \$3.00

PRINCIPLES OF RADIO

By KEITH HENNEY

A complete and authoritative presentation of radio, in its fundamentals as well as its recent developments. Partial list of contents includes: Ohm's Law; Inductance; Capacitance; Circuits; Coils; the Vacuum Tube; Amplifiers; Rectifiers; Oscillators; Television, etc. Profusely illustrated.

Fourth Edition 549 Pages \$3.50

SHORT-WAVE WIRELESS COMMUNICATION

By A. W. LADNER and C. R. STONER

A book of inestimable value in this field as it contains the latest facts and theory (as far as they may be released now) on the many leading American, English and European developments taking place in short-wave and ultra-short-wave work. 180 new diagrams, plus illustrations and calculations, supplement the text.

Fourth Edition 573 Pages \$6.00

HYPHER AND ULTRA-HIGH FREQUENCY ENGINEERING

By ROBERT I. SARBACHER and WILLIAM A. EDSON

A practical treatment of an important new branch of communications engineering, requiring no special advanced knowledge. Of value to the beginner as well as to those having some knowledge of the subject.

644 Pages \$5.50

BASIC ELECTRICITY for COMMUNICATIONS

By WILLIAM H. TIMBIE

A simple, clear presentation of the fundamentals of electricity and their application in the problems of communications and radio. The first twelve chapters illustrate the principles by simple application to communications appliances. The remainder of the book covers the appliances and their operation.

603 Pages \$3.50

RADIO RECEIVER DESIGN—Part I

By K. R. STURLEY

Communications Engineers will want to own this book, which covers radio frequency amplification and detection. A detailed study, stage by stage, beginning with the aerial and going as far as the detector.

435 pages \$4.50

GUIDE TO CATHODE RAY PATTERNS

By MERWYN BLY

Important for technicians and laboratory workers. This book summarizes briefly, by means of sketches and captions, the cathode-ray pattern types encountered in the usual course of laboratory and test bench work.

30 Pages \$1.50

FUNDAMENTAL RADIO EXPERIMENTS

By ROBERT C. HIGGY

Thirty-two basic experiments in electricity, electronics and radio, with a full explanation of the principles involved as well as laboratory procedure.

96 Pages \$1.50

TIME BASES (Scanning Generators)

By O. S. PUCKLE

Covers the subject from both the design and the development points of view; assembles more time bases circuits than have heretofore been available in one volume.

204 Pages \$2.75

COMMUNICATION CIRCUITS

By LAWRENCE A. WARE and HENRY R. REED

An eminently successful book now expanded to include new material on the physical aspects of wave guide transmission, impedance matching, solution of circuits, and the theory of rectangular and cylindrical wave guides.

Second Edition 330 Pages \$3.50

FUNDAMENTALS OF ELECTRIC WAVES

By HUGH H. SKILLING

Discusses the principles of wave action as applied to engineering practice, with particular emphasis on the basic ideas of Maxwell's equations and repeated use in simple examples; also on physical concepts and mathematical rigor.

186 Pages \$2.75

THE TECHNIQUE OF RADIO DESIGN

By E. E. ZEPLER

Deals with the day-to-day problems of the radio engineer, both in the development and in the testing of radio receiving apparatus of all types. Thoroughly practical.

312 Pages \$3.50

-----ON APPROVAL COUPON-----

John Wiley & Sons, Inc.

440 FOURTH AVE.
NEW YORK 16, N. Y.

Please send me on ten days' approval the books I have checked in this advertisement (or I am attaching to this coupon a separate list of the books desired). At the end of that time, if I decide to keep the books, I will remit indicated price plus postage; otherwise I will return the books postpaid.

Name

City and State

Address

Employed by

RC-5-44

Radio-Electronic Circuits

1 TUBE A.C.-D.C. SET

This one tube electric set uses a 12A7 as detector and rectifier.

A 40 watt lamp is used to reduce the line voltage to 12.3 volts.

One word of caution: Do not ground set. Standard plug-in coils cover the S.W. and B.C. bands.

BOB SMITH,
Montclair, N. J.

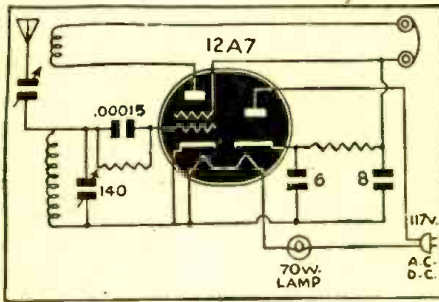

PHONO PRE-AMPLIFIER

The 24A should be shielded so that it will give best results for the amount of plate voltage used. The plate voltage can be as much as 180 volts and the amplifier still give good results. The higher the value of C3, the better the amplifier will work. All leads should be as short as possible as this will help the performance also.

The power for this amplifier was obtained from a power pack used on the work bench, which gave 480 volts at 10 mils, and had to be dropped with resistors. The power supply should be well-filtered.

NATHAN CROSSMAN,
Jacksonville, Texas.

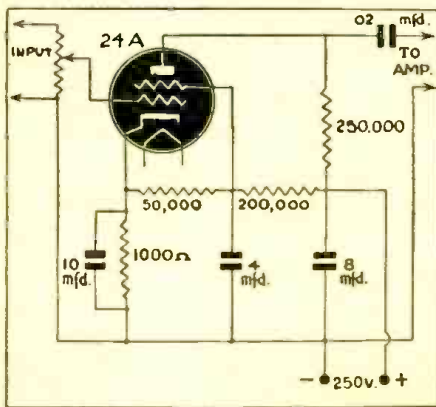

THREE-WATT AMPLIFIER WITH INVERSE FEEDBACK

This diagram is of a 3-watt amplifier using inverse feedback, and having an input circuit which gives a reasonable amount of quality control.

The amplifier was designed for phono-graph use, with the specific requirements of good reproduction combined with simplicity and compactness. All the parts including tubes are easy to obtain, and any well-filtered power supply of about 300 volts may be used.

While the construction is quite simple

EXPERIMENTERS!

Radio-Craft is initiating a plan to overcome the bottlenecks created by the unavailability of many standard types of apparatus. The ingenuity of the American experimenter, technician and mechanic is hereby challenged to replace, rebuild or substitute unrepairable or unobtainable equipment.

Every month one project will be announced for the readers of this page to exercise their brains on. Radio-Craft will pay a

FIRST PRIZE OF \$5.00

for the best answer and one-year subscriptions for all others published.

PROJECT FOR THE MONTH: Bottleneck No. 2—A simple and easily-constructed all-wave signal generator, accurate enough for fine service work, is needed on many a radioman's bench today. What can YOU do to solve this problem? Let's have circuits, photos and stories.

Suggestions from readers as to other bottlenecks are also welcome. What is your present pressing problem? If you want help with it, tell us so that we can all get to work on it.

and straightforward, all the usual precautions must be taken to avoid hum trouble. The whole input circuit of the original amplifier was built into an old I.F. can and mounted on top of the chassis. The shielded lead from the half megohm variable resistor was run through the chassis and to the grid of the 6SJ7, giving shielding as near perfect as possible.

HOWARD JOHNS,
Halifax,
Nova Scotia.

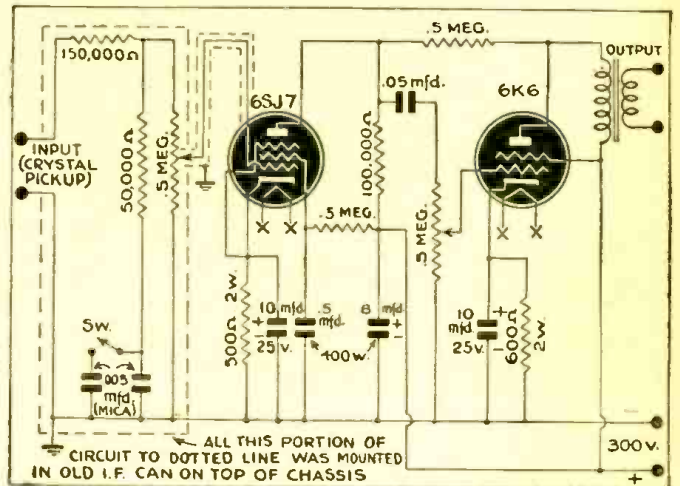

A.C. 5-TUBE BROADCAST RECEIVER

In the following diagram, be sure the Power Transformer is shielded or else the position towards the "Audio" must be so arranged or placed on the chassis to avoid undesirable hum. It can be located by turning the Power Transformer when the receiver is in operation already.

T1—Power Transformer 700 V.C.T
5 volts 3.5 amp.
6.3 volts .3 amp.

350-350 volts 120 milliamperes

T2—Audio 3:1 for single 6L6 Tube

T3—Universal output transformer

1—Speaker (8"-10") Electro-magnetic Speaker

R—All Resistors may be of 1 watt

All other values are given on the diagram.

EUSEBIO V. MANIQUIS,
Philippine Islands.

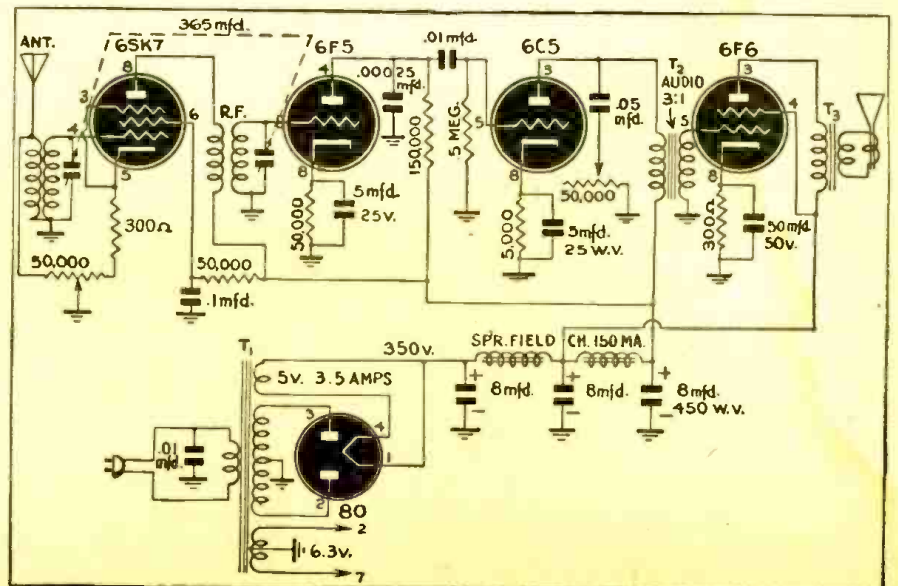



What good is a \$10.00 raise ... if it then costs you \$12.00 more to live?

SURE WE ALL want a raise . . . but raises today are bad medicine. Bad medicine for you. Bad medicine for everybody else. And here's why . . .

Suppose you do get a raise . . . and a lot of others get one, too. What happens? The cost of manufacturing goes up. Naturally your boss has to add this increase in cost to the price he asks the retailer. And the retailer, in turn, raises his price to the consumer . . . that's YOU.

Multiply these hundreds of items that everybody has to *pay more for* by the thousands of other workers who want raises . . . and by the thousands of business men and farmers who want more money for their products . . . result . . . you and all the others need another raise to make ends meet.

And so it goes . . . wages and prices chase each other up and up . . . until prices get so high that your dollar isn't worth a dollar any more.

So what good is a raise if your living

costs go up even faster? And there's so little you can buy today anyway . . . with most factories in war production.

Of course it's hard to give up the luxuries of life . . . and even harder to give up some of the necessities. But this is War! And when you think of the sacrifices our fighting men are making . . . many of them giving up their lives for us . . . no sacrifice we can make should be too great.

So if you want to be able to enjoy the good things of life in the peaceful days to come . . . if you want to speed victory and thus save the lives of thousands of fighting men . . . start doing these seven things now . . .

1. Buy only what you need. Take care of what you have. Avoid waste.
2. Don't try to profit from the war. Don't ask more than you absolutely *must* for what you have to sell . . . whether it's goods or your own labor you're selling.

3. Pay no more than ceiling prices. Buy rationed goods only by exchanging stamps. Otherwise, you're helping the black-market criminals, hurting yourself and all other good Americans.

4. Pay taxes willingly. They're the cheapest way of paying for the war.

5. Pay off your old debts—all of them. Don't make new ones.

6. If you haven't a savings account, start one. If you have an account, put money in it—regularly. Put money in life insurance, too.

7. Buy and hold War Bonds. Don't stop at 10%. Remember—Hitler stops at nothing!

Use it up . . . Wear it out.
Make it do . . . Or do without, **KEEP**

PRICES DOWN

A United States War message prepared by the War Advertising Council, approved by the Office of War Information, and contributed by the Magazine Publishers of America

JUST THE THING
FOR SPRING

SYLVANIA SERVICEMAN SERVICE

by
FRANK FAX



Below is a compelling die-cut, full-color window display piece ready for spring business promotion. It catches the eye of men and women alike — a lovely girl at her spring housecleaning. Measures 34 by 17¾ inches — a convenient size for window or inside store use.

AVAILABLE ONLY AT YOUR LOCAL SYLVANIA DISTRIBUTOR. **FREE!**



Listen WHILE YOU WORK

KEEP YOUR RADIO WORKING-TOP
REPLACE WORN TUBES WITH

SYLVANIA

RADIO TUBES

BUY DEFENSE BONDS AND STAMPS NOW

SYLVANIA

ELECTRIC PRODUCTS INC.

RADIO DIVISION • EMPORIUM, PA.

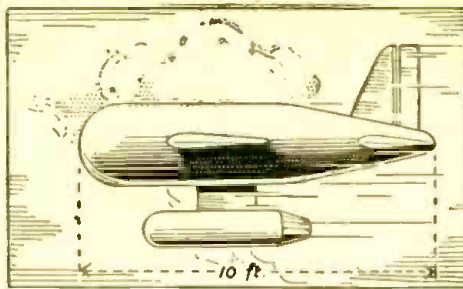

Radio Controlled GLIDER BOMB

The Henschel 293

THE above illustrations show the first authentic pictures of the Nazi radio-controlled glider bomb. The illustration at the left was taken from the *Aeroplane Spotter*, a British publication. That at the right shows a three-quarter view of top illustration.

The Radio-Controlled Glider Bomb was the subject of our November cover, illustrated below. At the time this cover was made, there was no picture in existence; the editors and our artist followed merely a cabled description of the Nazi machine. It will be noted that we came exceedingly close to the actual device. The only difference between the *Radio-Craft* cover design and the actual machine is in the tail.

The Henschel 293 follows the usual airplane design, the bomb with its radio mechanism forming the "fuselage." The rocket power is underneath the bomb and takes the place of the usual landing gear.

The Henschel 293 has a wingspread of 10 to 15 feet and is about 6 to 10 feet long. The full load weighs about 2500 pounds.

It is launched from the latest design of the Dornier 217 bomber and by the still larger Heinkel 177.

The radio-controlled glider bomb is controlled from the parent craft, and it is be-

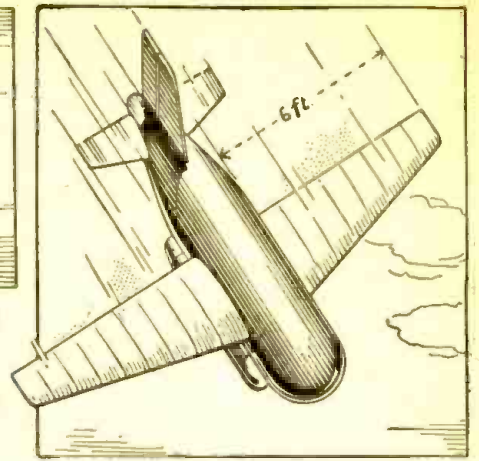

lieved to reach a maximum speed of 300 miles an hour.

Radio-Craft has been informed that at the Anzio beachhead below Rome, these Nazi glider bomb attacks have always been launched at dawn or dusk. This gives the maximum protection for the launching parent craft and makes it more difficult for the fighter opposition to interfere.



The way the radio-controlled glider bomb appeared on our November cover.

BLACK LIGHT GUARDS ENGLAND (Continued from page 472)

invention were subjected to a practical test. Fifty-one "enemy" ships were under orders to attack the coast. The attack was, however, beaten off by a single coastal battery, the guns of which were directed by secret rays. The fire was so accurate that forty-eight out of the fifty-one attacking ships were put out of action or "destroyed." One of the three surviving ships that took to flight was also said to be "heavily hit" . . .

In this method of infra-red defense the Americans use searchlights with mirrors of five feet in diameter. The mirror surface is made of rhodium, a metal capable of resisting great heat concentrations.

Improvements in the receivers of infra-red ray recording apparatus must be of decisive importance for the work of aircraft detection. In America, the television expert, Dr. Zworykin, has collaborated with the aircraft expert, Dr. Morton, to improve the infra-red eye. In Germany, the Institute for Ray Research is also at work, and the results obtained are put to practical use in the Zeiss Works at Jena. One of these is embodied in a patent covering a device operated by infra-red rays in conjunction with an aiming device for A.A. guns. Thus we gain some idea of the extensive scale on which the infra-red method is used.

The "Third Eye" is the name given to an apparatus for recording heat rays which

Dr. V. K. Zworykin and Dr. G. A. Morton have built in the laboratories of the Radio Corporation of America. They did not use the sensitivity of the selenium tellurium cell to conduct electric current when exposed to infra-red rays, but preferred to exploit photo-electric effects. When placed in a vacuum, certain alkaline metals begin to emit electrons if exposed to long-wave red light. This phenomenon has been effectively applied by Zworykin and Morton.

Potassium and caesium electrodes, held in equal electric tension by opposite electrodes, are placed in a vacuum glass tube. If a minute infra-red ray, emanating from a distant mark which has been focused in a gunsight, reaches the "Third Eye's" apparatus, it will be picked up by a system of lenses and projected on to the electrode composed of alkaline metal. The infra-red light causes this electrode to emit electrons which are thrown on to the second electrode by the electric tension. A current begins to flow. Although weak, it can be increased at will by means of amplifier tubes and finally converted into visible light. By means of the artificial "Third Eye," our own natural eyes locate the distant invisible object through fog and clouds and even in the darkness of the night.

Condensed from "On the Way to Electro War" (Gifford, London).

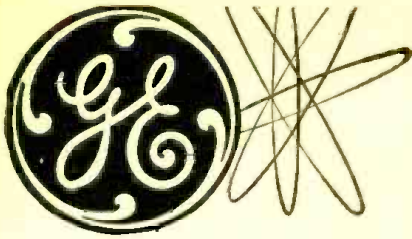

... PORTABLE TUBE CHECKER

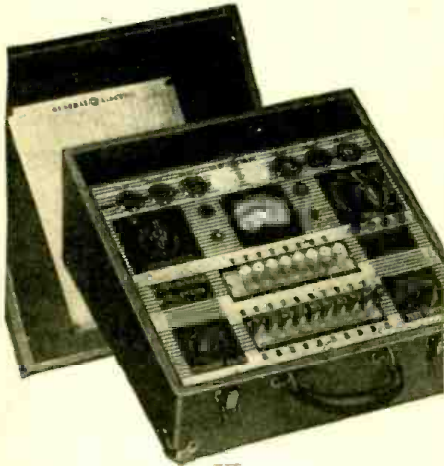

THIS portable G-E Tube Checker contains sockets for all American tube types . . . provides practically a complete service shop of tube analyzing equipment. Equipped with the ingenious PMT Circuit Switch, this instrument is just one in the new General Electric line of SERVICE TESTING EQUIPMENT.

Among the other sturdy G-E units available for testing electronic circuits and component parts are: G-E uni-meters, audio oscillators, oscilloscopes, condenser resistance bridges, signal generators and other utility test instruments. For complete details about these accurate instruments, please fill out the coupon below. . . .

FREE
CATALOG



ELECTRONICS
DEPARTMENT
GENERAL ELECTRIC CO.
Schenectady, N. Y.

Please send, without obligation to me, the General Electric Testing Instrument Catalog, R-5 (loose-leaf), for my information and files.

Name _____

Company _____

Address _____

GENERAL ELECTRIC
177-C4
Electronic Measuring Instruments

RADIO WEATHER CONTROL (Continued from page 459)

If any rain is required, it should preferably be between the hours of two and five in the morning when there is the least amount of traffic and the least inconvenience to the public. That would be the ideal weather control for cities. Contrary-wise, in the country where rains are needed for crops, forests, etc., a larger amount of precipitation is required and general droughts should be avoided.

How then can conditions of this type be controlled? I believe that in the future it will be possible to obtain precipitation *when and where* it is required and to stop it where it is *not* wanted. I can envisage a large metropolitan area surrounded either by high towers, small captive balloons, or special types of kites about a mile apart, ringing the city as European cities now are ringed by aerial barrage balloons.

For weather control purposes, these towers, balloons or kites have only one purpose, and that is to electrify the atmosphere and to break up rain or snow clouds so that no precipitation shall occur within the protected area.

The towers, balloons or kites would simply be lofty aerials which radiate radio frequency energy of the proper frequencies in such a manner as to affect the clouds, so that no precipitation should occur over a specified area.

When I speak of radio frequency energy, I have in mind frequencies of the type of Tesla currents of an *extremely high voltage—so high, in fact, that there will be a continuous corona effect radiating from the top part of the antenna.* This would be necessary if the surrounding air is to be properly electrified and saturated. Experiments will show how much energy is to be radiated and, further, *HOW* the energy is to be radiated. It may be found that this will not be in a continuous flow, but it may be necessary to electrify the surrounding medium by means of certain rhythmic pulses, as a locomotive piston expels steam rhythmically into the atmosphere.

It is admitted that a vast amount of experimentation will be necessary in order to accomplish this, but I believe in the end

it can be achieved. In this case, one or two things would occur. Either the precipitation would be outside of the area or, due to the electrification, the clouds would ascend higher which would insure that the precipitation would occur at some other point or not at all. It is even within the realms of possibility that the lofty transmitters could impart a different direction to the clouds from their original path. This would be done by successively switching one transmitter to another in order to create a new motion, the purpose being to turn the clouds away from the area in which they are not wanted.

If we had some such installations across the country, and if the various centers were properly coordinated, it is believed that even violent storms could be broken up and that the precipitation will occur where it is most needed.

In the very nature of this scheme, it will be realized that the special transmitters which supply the energy are only turned on when needed, and as they will in all probability be of a high frequency, normal radio broadcast transmissions will not be affected by these transmissions.

When it is realized that a fair-sized snowstorm costs a city of the size of New York at least two million dollars, just for the removal of the snow, and countless other millions in inconvenience, slowed down traffic, impairment of health to the inhabitants, etc., the cost of equipping a city with a ring of weather-control apparatus would seem puny in comparison.

It should also not be forgotten that for war purposes, weather control is even more important than any other consideration. Battles are won or lost on account of weather that affects troop and troop movements adversely. I can foresee portable weather-control equipment in the future, and it is even within the realms of possibility that such areas, as for instance, the Aleutian Islands—which are notorious for unbelievably bad weather conditions—can be affected so that instead of being shrouded in mist and fog 80% of the time, the condition can be reversed.

ELECTRONS CHECK RIPENESS OF FRUIT

THE housewife who formerly squeezed oranges or pineapples and thumped melons to determine their ripeness may now tune fruit by radio to find out whether it is just right for eating. A grapefruit, for example, located in a radio circuit, instead of the usual electric condenser or resistance unit, "looks like a stranger in a strange land," and the hook-up has such amazing implications as to tax our credulity.

This novel radio device, which uses electronic tubes similar to the vacuum tubes in our radio receiving sets, is a joint invention of Howard L. Clark of Ballston Lake and Walter Mikelson of Schenectady, New York. Patent rights to the invention have been assigned to the General Electric Company.

The instrument operates in accordance with the principle that green grapefruit, green apples, oranges, bananas, pineapples, and melons set up vibrations more readily than ripe fruit. Or, putting it differently, a green melon will do the Gilda Gray shimmy more than a ripe one. The electric behavior of the trembler of an electric bell, a vibrating reed in a reed organ, or a vibrating reed for sending and receiving electric

currents in a harmonic telegraph system, has been imitated in designing the fruit-ripeness tester. This difference in the shimmying effect of ripe and green fruit is measurable with scientific precision.

Electron tubes are employed in a suitable radio circuit with feed-back oscillator (a form of radio transmission so common in the heyday of wireless experimentation) for transmitting the vibrations or trembling effects set up in a pineapple or grapefruit. The two essential units of this invention are a vibration pick-up device and a radio receiving set. A phase shifter (a common electrical device) is included somewhere in the current of this vibrating machine as a means of obtaining quickly a phase relationship favorable to regenerative action.

In this fruit-ripeness tester, the generated vibrations or shimmying effects are intercepted by the vibration pick-up unit, these trembles are converted into pulsating electric currents, amplified, and then reconverted into mechanical vibrations. The natural period of such vibration, according to tests by the inventors, decreases with the degree of ripeness of the sample of fruit under observation.—S. R. W.



You're really due a pat on the back. The war effort has made the tools of your profession mighty scarce, but the case is rare that you've failed to keep your customer's radio in operation.

Sure, you've scratched your head over a job that required a substitution. The proper type tube was no longer available. The socket had to be changed, pin connections re-wired. Boy, what fun! But the darn thing worked . . . and did it tickle the set owner! Another receiver snatched from the graveyard.

Thousands of thousands of similar problems are solved daily by you and your brother servicemen. And your sixth sense . . . your test equipment . . . is helping you do the job. We at Supreme are proud that with many servicemen this sixth sense is Supreme Test Equipment.



Model 504-A
Tube and Set Tester

Today SUPREME is engaged 100% in war production. When conditions permit, Supreme again will be engaged 100% in producing test equipment that will make YOUR work as a serviceman simpler, surer, faster, more profitable.



WORLD-WIDE STATION LIST (Continued from page 482)

Mc.	Call	Location and Schedule	Mc.	Call	Location and Schedule
11.900	KWIX	SAN FRANCISCO, CALIF.; Australian beam, 1 to 7:58 am; 4 to 7:30 pm.	15.230	WKRX	NEW YORK CITY; Central African beam, 4:15 to 5:15 pm.
11.900	XGOY	CHUNGKING, CHINA; Asia-Australia-New Zealand beam, 6 to 6:30 am; East Russia beam, 6:30 to 7 am; Japan beam, 7 to 7:30 am; European beam, 11:35 am to 12:30 pm.	15.230	—	MOSCOW, U.S.S.R.; off at 7:25 pm.
11.905	—	UNITED NATIONS RADIO—ALGIERS; off at 4 pm; same as 9.535 mcs.	15.230	WKRD	NEW YORK CITY; Central Africa beam, 7 to 9 am.
11.910	ZRO	ROME, ITALY; off since September	15.240	TPC5	VICHY, FRANCE; 11:15 am to 1:30 pm.
11.948	—	MOSCOW, U.S.S.R.; 8:45 to 9 am.	15.250	WLWK	CINCINNATI, OHIO; European beam, 8:30 am to 5:15 pm; West South American beam, 5:30 to 8:15 pm.
11.970	FZI	BRAZZAVILLE, FRENCH EQUATORIAL AFRICA; "Radio Brazzaville"; 4:45 to 8 pm.	15.260	GSI	LONDON, ENGLAND; African service 11 am to 5 pm.
12.000	—	LISBON, PORTUGAL; Oriental beam, 8 to 10 am.	15.270	WCBX	NEW YORK CITY; European beam, 7 am to 4:45 pm.
12.040	GRV	LONDON, ENGLAND.	15.29	KWID	SAN FRANCISCO, CALIF.; South American beam, 1 to 9 pm.
12.060	FFZ	SHANGHAI, CHINA; heard at 8 am.	15.300	ZRO6	ROME, ITALY.
12.070	CSW	LISBON, PORTUGAL; 9:30 to 10 am.	15.31	GSP	LONDON, ENGLAND; 10 am to noon.
12.110	H13X	TRUJILLO CITY, DOMINICAN REPUBLIC; new frequency at 5 pm.	15.320	JFY	TAIHOKU, JAPAN.
12.115	ZNR	ADEN, ARABIA; off at 1:16 pm; heard daily.	15.330	WGEO	SCHENECTADY, NEW YORK; European beam, 7 to 9:45; 10 am to 3 pm.
12.235	TFJ	ICELAND; heard early mornings; irregular.	15.350	WRUW	BOSTON, MASS.; Caribbean beam, 6:15 to 7:15 pm.
12.27	COCB	HAVANA, CUBA; daytime.	15.350	WRUL	BOSTON, MASS.; North African beam, 10 am to 1:30 pm; European beam, 1:45 to 2:30 pm.
12.445	HCJ8	QUITO, ECUADOR; "Voice of the Andes"; 5 to 11 pm, except Monday; in English at 10 pm.	15.355	KWU	SAN FRANCISCO, CALIF.; N. E. 1 beam, 7:45 to 9:30 pm; off on Wednesdays; Sundays, 4:45 to 9:30 pm; South American beam, 11 am to 2 pm.
12.967	WKRD	NEW YORK CITY; European beam, 1 to 6:30 pm.	15.370	ZYC8	RIO DE JANEIRO, BRAZIL; 10 am to noon; evenings.
12.967	WKRX	NEW YORK CITY; North African beam, 6 to 8 am.	15.140	PZP	PARAMARIBO, DUTCH GUIANA; variable times calling New York City stations.
13.085	COCH	HAVANA, CUBA; afternoons.	15.410	RV96	MOSCOW, U.S.S.R.
14.10	—	DAKAR, FRENCH WEST AFRICA; Sundays, 2:45 to 5 pm.	15.420	GWD	LONDON, ENGLAND; 11 am to noon.
14.460	DZH	BERLIN, GERMANY; 10 to 10:45 am.	15.45	GRD	LONDON, ENGLAND.
14.480	—	EL SALVADOR; 1 pm to 7	15.465	ZRO24	ROME, ITALY.
14.56	HVJ	VATICAN CITY; 9 to 10 am.	15.810	LSL3	BUENOS AIRES, ARGENTINA; heard at 6:45 pm.
15.070	GWC	LONDON, ENGLAND; 10 to 11 am.	16.025	AFHQ	ALLIED HEADQUARTERS, NORTH AFRICA; daily, 9:18 to 11:30 am (calls GBC and GBI).
15.105	JLG4	TOKYO, JAPAN; 2 to 4 am, heard some times in the evenings.	17.72	LRA5	BUENOS AIRES, ARGENTINA; "Radio Del Estado"; Fridays, 5 to 5:30 pm.
15.110	GSF	LONDON, ENGLAND.	17.750	WRUW	BOSTON, MASS.; European beam, 10:45 am to 1:30 pm; 1:45 to 2:30 pm.
15.11	DJL	BERLIN, GERMANY.	17.760	KROJ	LOS ANGELES, CALIF.; Australian beam, 9 to 10 pm.
15.11	—	MOSCOW, U.S.S.R.; 9:15 pm and 11:15 pm; 5:15 to 5:40 pm.	17.760	WKRD	NEW YORK CITY; South African beam, 10 to 11:15 am.
15.130	WRUS	BOSTON, MASS.; North African beam, 1:45 to 4:30 pm; European beam, 7:45 am to 1:30 pm.	17.760	WKRX	NEW YORK CITY; Central African beam, 11:30 am to 4 pm.
15.14	GSF	LONDON, ENGLAND; 10 am to noon.	17.780	WRCA	NEW YORK CITY; European beam, 8:15 am to 2:45 pm.
15.150	WRCA	NEW YORK CITY; Brazilian beam, 5 to 7:45 pm.	17.780	WN8I	NEW YORK CITY; East South American beam, 5:30 to 6:45 pm; Sundays, 5:30 to 7:30 pm.
15.150	WN8I	NEW YORK CITY; European beam, 7:45 am to 3:30 pm.	17.800	WLWO	CINCINNATI, OHIO; European beam, 8:15 am to 2:30 pm; West South American beam, 5:30 to 6:45 pm.
15.155	SBT	STOCKHOLM, SWEDEN; heard daily, 11 am to 2:15 pm.	17.800	TGWA	GUATEMALA CITY, GUATEMALA.
15.165	PRE9	FORTALEZA, BRAZIL; evenings.	17.830	WCDA	NEW YORK CITY; European beam, 8:15 am to 1:45 pm.
15.170	TGWA	GUATEMALA CITY, GUATEMALA; daytimes.	17.870	GRP	LONDON, ENGLAND
15.190	KROJ	LOS ANGELES, CALIF.; N.E. 1 Oriental beam, 2:30 to 8:45 pm; 7 am to 2:45 pm.	17.950	—	UNIDENTIFIED; signs off about 3:18 pm with "La Marseillaise."
15.190	WOOC	NEW YORK CITY; European beam, 7 to 9:45 am; 5:50 to 8:30 pm.	18.000	NGK4	UNKNOWN; heard calling San Francisco for relay broadcast.
15.20	DJ8	BERLIN, GERMANY; North American beam, 7 to 9:45 am; 5:50 to 8:30 pm.	18.135	YDA	BATAVIA, JAVA (Netherlands Indies); 10:00 to 10:30 pm.
15.210	WBOS	BOSTON, MASS.; European beam, 7 am to 3 pm; East South American beam, 5:30 to 8:15 pm.	20.040	OPL	LEOPOLDVILLE, Belgian Congo.
15.220	—	"VOICE OF FREE INDIA"; 10 am to 12:05 pm.			
15.225	JTL3	TOKYO, JAPAN; 6:15 to 8:15 pm; news in English at 6:20 and 7:20 pm.			

THE NOISE PRIMER

PUBLISHED by General Radio Company, this booklet, according to its author, is neither an instruction book nor a text book, but a concise compilation of the elemental principles and procedures in the measurement analysis of sound and vibration.

As such, it is highly successful. The similarity to the human ear is shown and its differences pointed out, as a guide to understanding its application. The decibel is explained for the benefit of industrialists and engineers who, while highly trained in their own technical fields, may not be completely familiar with the principles of acoustics and electronics.

Practical application of sound-level meters and sound analyzers occupy the greater part of the book. The problems of instrument placement, as well as the more technical ones concerning the usefulness of sound analysis in special cases, are fully treated. All in all, the book is an extremely useful one for the engineer or industrialist who may have sound problems. The sound engineer will also find it handy at times.

It runs to 43 pages, 6 x 9 inches. The large number of graphs enhance its value. The book is free to serious inquirers. Address requests on company letterhead only. To Noise Primer, % Radio-Craft, 25 West Broadway, New York 7, N. Y.

RUSSIA'S ELECTRON ROBOTS

(Continued from page 467)

made of copper and glass and electrons sits in an office, but its arms and hands are half a mile away, working in a machine shop!

What on earth does such a contraption work at? Just this: its photo-electric eyes read a new type of blueprint. This blueprint shows the design of a complicated piece of machine work—say, a steel fitting for a big gun breech. *The robot reads the blueprint, flashes electron-thoughts over its wire nerves to its electrical hands, and these hands operate all the controls of a huge metal-turning lathe.* In other words, this machine takes the place of a human lathe operator.

But the purpose of this Soviet invention was not to displace human labor. In several important respects the robot machinist is far superior to the most highly skilled human worker. First, it reads the blueprints with highest accuracy, and the lathe tools follow this accuracy at all times. This makes possible mass production within extremely close limits. Then again, the robot cannot possibly make an error. Its machining never needs to be checked, for what is on the blueprint will be in the finished piece. All parts are identical. There is no unevenness in the work, as is the case even in the most automatic of operations, if they depend in the final analysis on human hands. Further, the robot machinist works twenty-four hours a day without rest periods. It never gets tired or sick, or has an accident. Finally, this astounding machine with one set of eyes and one glass-tube brain can control two, a dozen, fifty, a hundred lathes—all turning out the same job!

Anyone can appreciate what such an invention means to the mass production of high-quality heavy armaments. It was to this invention and others of somewhat similar nature that Shcherbakov referred when he spoke of new methods worked out by Soviet scientists for the utilization of Russian raw materials, methods "of great importance for the country's military might." The Soviet Union solved the "impossible" problem of training many thousands of highly skilled machine operators within a period of a few months. The problem was solved by turning the machine over to electronic brains. To train these robot operators how to run a new machine is simply a question of handing them a new blueprint. No design looks strange to electron eyes.

Condensed from "Russia's Secret Weapon" by Major A. S. Hooper, London.

A CORRECTION

There were two errors in the drawing of the "Post-War 2-Tuber," published in our March issue. No plate supply is furnished to the pentode section of the 12B8-GT. A lead should run from the junction of the 30-henry choke, the 16-mfd. condenser and the phones (high-voltage output) to the junction of the two 100,000-ohm resistors in the plate circuit of the pentode section of the tube.

The second error deprives the set of a negative return to the line. The cross-over, where the lead from the 330-ohm resistor runs to the 0.1 condenser, should be a solid connection. This cross-over may be seen right beside Sw.

The drawing in question was on page 348 of the March *Radio-Craft*. Acknowledgment is made to the two readers and the author, who kindly called our attention to the error.

"Radio Rebuilding"

Announcing our new

Radio Repair Service Department!

All Service Guaranteed • Radios Completely Rejuvenated
Work Done By Expert Technicians

We are proud to do our part by providing a Radio Repair Service by skilled specialists for those of our friends who need radio repair service facilities because their service men have joined Uncle Sam's forces. If your radios need servicing or if the volume of your business is too large to handle, CHICAGO NOVELTY'S RADIO REPAIR SERVICE DEPARTMENT is at your disposal. No radio too large or too small. We can handle radio repair work in quantity. New cabinets furnished where necessary. Radios must be kept in perfect condition to bring you war news, entertainment, and information and to keep up the morale of the home front.

Ship us your radios by express or parcel post. We will return them carefully boxed so that they will reach you in guaranteed excellent condition.

CHICAGO NOVELTY COMPANY, INC.

1348 NEWPORT AVENUE . . . CHICAGO 13, ILLINOIS

MODEL
No. 1632

*Signal
Generator*

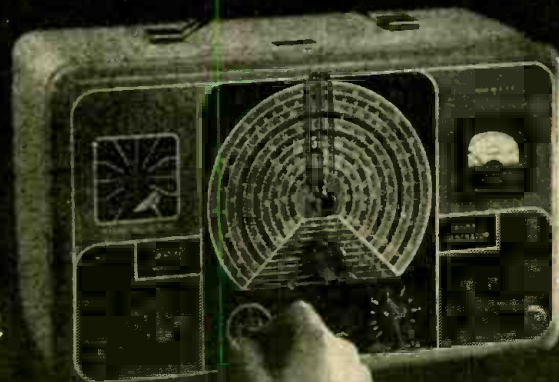

Continuous coverage—100 KC to 120 MC—
all frequencies fundamentals. New high frequencies for frequency modulated and television receivers. All coils permeability tuned. Litz wire wound against humidity with "high"-Q cement. This and other models will be available to you after the war.

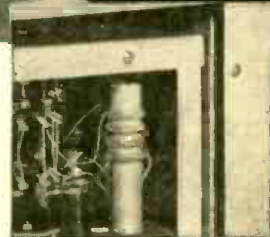

Triple shielding throughout. Steel outer case, steel inner case plus copper plating.



Triplet

ELECTRICAL INSTRUMENT CO.

Bluffton Ohio ★ ★ ★

Centralized... to
Serve You Efficiently!

**LARGEST and MOST
COMPLETE STOCKS**
of RADIO
**AND ELECTRONIC
EQUIPMENT**
Under One Roof

FREE
most complete
up-to-date
**BUYING
GUIDE**



**REPAIR and
REPLACEMENT
PARTS
AVAILABLE
without priority**

Save time—
Call Allied first

The world's largest
stocks are centralized
in this single arsenal

of supply. Over 10,000 items from all leading manufacturers . . . for the Armed Forces, Radio Training, Research Laboratories, War Industries and Service Replacements. Our experienced staff helps speed delivery. Save time—simplify procurement—call **ALLIED first!** Thousands do.

Write, wire or phone Haymarket 6800.

6 Radio Books for 75c

Dictionary of Radio Terms. No. 37-751 10c	Radio Data Handbook. No. 37-754 25c
Radio Circuit Handbook. No. 37-753 10c	Radio Builders Handbook. No. 37-750 10c
Radio Formulas & Data Book. No. 37-752 10c	Simplified Radio Servicing. No. 37-755 10c

All Six Books No. 37-799 . . . 75c
Write for Quantity Prices

ALLIED RADIO CORP., Dept. 2-E-4
833 W. Jackson Blvd., Chicago, Ill.

Please send following books (.....c enclosed)
 FREE 37-750 37-752 37-754
Buying 37-751 37-753 37-755
Guide No. 37-799 (All Six Books)

Name.....
Address.....
City..... State.....

ALLIED RADIO

SMALLER PACKS FOR PORTABLES (Continued from page 473)

and 15-ohm filter resistor is kept away from the filter condensers and selenium rectifier which should, by the way, operate with an ambient temperature of not over 35 or 40° C. For these reasons, the parts should be located as shown in the sketch. It will be noted that the parts which dissipate the most heat (rectifier tube, filament and filter resistor) are all on one side of the cabinet. Holes are drilled in the top cover and on the bottom of the sides, or on the bottom plate if preferred, so that the heat will rise and pass out through the top. Cold air will then rush in at the bottom to take its place thus creating a draft which will effectively carry off the heat. Holes are drilled on the other side of the top above the transformer and rectifier and also on the lower part of the side plate or bottom so that effective ventilation is also secured on this side, although the heat from these units is not very great. (See sketch for further details regarding special brackets for rectifier tube and dry disc rectifier.)* The two 10-watt resistors are mounted in an upright position by means of long screws and fiber washers. The condensers are held in place by means of small metal straps. Rubber grommets should be used if available for both the power cord and 4 wire cable where they pass through the metal of the cabinet. The line cord should be knotted on the inside so that it will not pull out through the grommet. The four-wire cable should be anchored just inside the cabinet. Since space is at a premium here the following is a good way to anchor it. Wind three turns of bare hook up wire around the cable. Twist the ends of the wires together with a pair of pliers and

solder the twisted ends to the cabinet. This will hold the cable securely in place. The self-tapping screws which hold the bottom securely are made as shown in the sketch to act as legs to keep the unit up so that air can come in through the bottom. Small pieces of felt can be cemented on the bottom of these legs to give a finished job. After the wiring is completed it will probably be advisable to paste the schematic on the under side of the top cover between the two rows of ventilation holes for future reference.

CONNECTION TO RADIO

This unit is connected to the radio by means of the four-cable socket and plug. There is just room to fit the four-contact socket into the radio case. (See photograph for location.) Connections to the socket are made as shown in the schematic. The regular battery plug in the set is taped up and not used until such time as batteries are again available. The set is turned on and off by means of the power switch on the power supply. Since the unit is connected directly to the power tube, the ON-OFF switch in the radio will not turn set on and off when the power supply is used.

The power supply works very well with this set. There is no hum and the volume is about twice that obtained when the set is operated on batteries. This is due in part to the higher "B" voltage, 65 as against 45 V.

This power supply has been in constant use in one of the army camps for over three months and is giving excellent service. It is hoped that the information given in this article will be of value to all those constructing power packs for the personal portables and in particular to those who are constructing them for boys in the armed forces.

*The choke should be moved over more toward the transformer than is shown in the sketch to provide more efficient cooling of the disc rectifier.

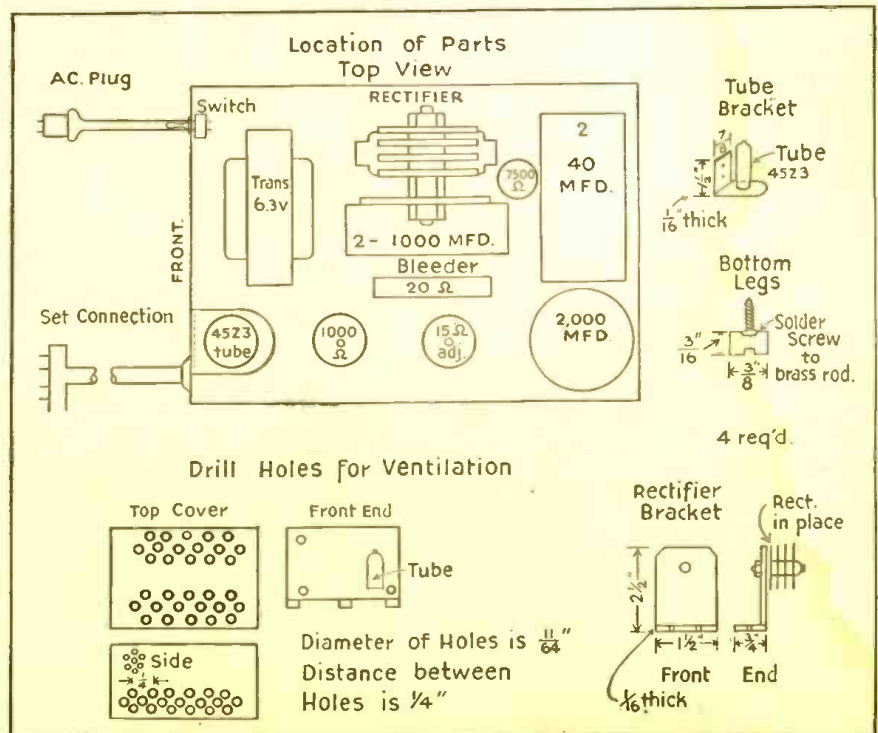

Layout diagram and a few details of the pack. Ventilation is important in such a small unit.

The following components were used in the construction of this receiver.

It is of course understood that obtaining the exact parts is absurd in these days. The list will nevertheless be useful as a guide.

Parts List

CONDENSERS

- 2—Cornell-Dubilier Type BRH 610, 1000 Mfd, 6 V. elect. condensers.
- 1—Cornell-Dubilier Type BRH 620, 2000 Mfd, 6 V. elect. condenser.
- 2—Sprague—"atoms"—40 Mfd. 250 V. elect. condensers.

RESISTORS

- 1—IRC type ABA—1000 ohm, 10 watt adjustable resistor.
- 1—IRC type ABA—15 ohm, 10 watt adjustable resistor.
- 1—IRC type BT2—7500 ohm, 2 watt resistor.
- 1—IRC type BT2—20 ohm, 2 watt resistor.

TRANSFORMERS AND CHOKES

- 1—Thordarson No. T-19F80—6.3 volt filament transformer.
- 1—Thordarson No. T-13C26—choke. (See text.)

MISCELLANEOUS

- 1—RCA or equivalent—45Z3 rectifier tube.
- 1—Benwod Linze—Type 1COB1B1—selenium rectifier or equivalent. Type 2COB1B1 for 250 Ma drain sets.
- 1—I.C.A. metal cabinet—No. 3811 size 3" x 5" x 4".
- 1—Belden cable No. 8444—4 wire 12 inch length.
- 1—AC cord with fused plug, 6 ft. length.
- 1—DPST toggle switch.
- 1—Amphenol-type 78-7P miniature socket for 45Z3 tube.
- 1—Amphenol-type 70-26 hearing aid 4 prong plug.
- 1—Amphenol-type 77-26 hearing aid 4 contact socket.

POST WAR TELEVISION NOW

(Continued from page 462)

for the telecast, and a larger staff of trained personnel is required. Those who appear before the camera must either speak extemporaneously or memorize their parts, either of which is definitely more difficult than simple reading from a radio script.

It may be possible to make a closer comparison with motion picture production, but here again there are decided differences. On the movie set retakes are frequent. The film may be viewed and edited. Undesirable footage may be deleted completely or cut down. In some cases, action is taken silently and the sound is dubbed in afterwards, the actors reading from scripts. Not so in television. None of these tricks may be used for a live studio program. A word or gesture goes over the air as it happens and there is no chance for corrections.

So a video and audio studio, independent or station operated, can be well utilized in testing and rehearsing program material as well as complete programs. Not to speak of the variety of television props that must be produced to help put over the video as well as the audio part of the show. This includes anything from trick titling machines to model houses or puppets.

In designing the studio setup, an attempt was made to reproduce conditions at the telecasting studio, in order that special effects, camera and mike technique may be developed before the program gets to the television studio for telecasting.

Needless to say, the Workshop is far from being as complete as its staff hope to make it. In spite of all the drawbacks connected with operation at this time, its staff feel that in presenting "post-war television now" they are helping to accelerate the spread of television after hostilities cease. Methods and techniques are being tried out—on a laboratory scale as it were—and these experiments point the way to successful television practise. Such experience gained now will be of incalculable value when genuine post-war television starts up and the entire industry is ready to "go to town" in a big way.

HARRISON HAS IT!

**FOR URGENT
WAR WORK—**

HALLICRAFTERS

**RECEIVERS AND
TRANSMITTERS**

TUBES

**CONDENSERS
RESISTORS
TRANSFORMERS**

**AND THOUSANDS OF OTHER
CRITICAL ELECTRONIC PARTS!**

PURCHASING AGENTS—

Call upon us for your high priority requirements of equipment and components for your production and development work.

We usually have it in stock!

**FOR THE
HOME FRONT—**

CODE PRACTICE SET

Buzzer and key, heavily nickel plated, of single unit construction, mounted on wood base. Adjustable high frequency pitch. Complete with silk covered cord. In attractive box with code chart on cover. Works on one or two flashlight or dry cells.

Postpaid—\$2.45

6L6G First grade, \$1.37 ea.
TUBES meter tested, 3 for \$3.75
fully guaranteed postpaid

DYKANOL CAPACITORS

Cornell-Dubilier oil filled, hermetically sealed metal cased condensers. 4 mfd. capacity. Rated at 220 Volts AC working, will stand over 600 Volts D.C. Ideal for amplifiers, receivers, power packs, etc. (Filtering action equivalent to 12 mfd. electrolytic but with better safety factor, longer life). \$2.25 (3 or more shipped postpaid).

P. M. DYNAMIC SPEAKERS

5 inch, with output transformer to match single plate of 8000 ohms \$1.95

(Not Postpaid)

Immediate delivery of the above items, without priority, while quantities last. Place L-265 or V-3 certification on your order. SEND REMITTANCE WITH ORDER, TODAY! (Money back if not satisfied.)

HARRISON
RADIO CORPORATION

11 WEST BROADWAY

Phone WOrth 2-6276

NEW YORK CITY 7

HALLICRAFTERS ★ HALLICRAFTERS ★

**LET'S ALL
PITCH IN!**

WE CAN all help win this war by selling our government the communications receivers and equipment they need quickly and in sufficient quantities.

That is the reason I pay highest cash prices for used communications equipment.

When this war is over you will be in the market for new equipment and by taking advantage of my offer to purchase your present equipment at highest cash prices you will be in a position to buy new and better equipment than you now own.

Write, telephone or telegraph me description of your used communications receivers, transmitters and parts of standard make; you will be paid cash immediately without bother or red tape. I am particularly interested in Hallcrafters.

I also have a store at 2335 Westwood Blvd., West Los Angeles, Calif.

Bob Henry, W9ARA
HENRY RADIO SHOP
BUTLER, MISSOURI

COMPLETE STOCKS

I have large stocks of receivers available for immediate delivery on priority and the following parts without priority: meter rectifiers \$1.95, meters, tubes, transformers, resistors, condensers, panels, chassis, etc. Your orders and inquiries invited.

"WORLD'S LARGEST DISTRIBUTOR OF COMMUNICATIONS RECEIVERS"





● In keeping with the wartime spirit of minimum types for maximum jobs, Aerovox offers these Victory Paper Tubulars. Eight selected capacitance values, used individually or in combinations, take care of upwards of 90% of usual paper capacitor replacements. Non-inductive paper sections. Extra-wax-sealed. Colorful label jacket. Bare pigtail terminals that won't work loose.

AEROVOX VICTORY PAPER TUBULARS

D.C.W.V.	CAPACITY
600	.001 mfd.
600	.002 mfd.
600	.005 mfd.
600	.01 mfd.
600	.02 mfd.
600	.05 mfd.
600	.1 mfd.
600	.25 mfd.

● See Our Jobber ● ● ●

Ask him about Aerovox Victory Tubulars—also Aerovox Victory Electrolytics. Ask for latest catalog—or write us direct.



AEROVOX CORP., NEW BEDFORD, MASS., U. S. A.
 In Canada: AEROVOX CANADA LTD., HAMILTON, ONT.
 Export: 13 E. 40 St., New York 16, N. Y. Cable: 'ARLAB'

AUDIO DISTORTION

(Continued from page 475)

must take place in the case of dielectric hysteresis in condensers. Thus transformers and condensers are guilty of a heretofore unsuspected source of audio distortion.

If a radio receiver's speaker be disconnected from the receiver and the gain control be turned up, the radio signals can sometimes be plainly heard as they are "sung" out by the power output amplifier tube's electrodes. Obviously an electro-mechanical transducer type of FM audio distortion is being generated by the vibrating tube electrodes. This microphonic type of tube distortion might be investigated in the case of transmitting tubes, especially.

FM distortion is probably present within an amplifier tube's circuit itself as well, since a tube's plate current varies somewhat with the amplitude of the signal applied to the control grid. If a strong low-frequency signal is fed into the grid, the plate current will vary somewhat at the low frequency rate. That means that its transconductance and other characteristics may vary slightly at that rate. The higher frequency signal may then be slightly "wobulated" at that lower frequency.

FM audio distortion is difficult to detect and recognize with the unaided ear, even by an experienced observer. It has a bafflingly familiar quality which might be best described as a sort of a cross-modulation type of masking "hash." It is serious in the case of speakers and should receive much more attention than it has up till now. Again, the futile and misleading harmonic distortion method of rating sound equipment has kept this important distortion effect hidden in the background just as in the case of inter-modulation distortion.

This may be considered a special form of frequency-modulation distortion. It occurs in recording play-back work when the speed of the play-back equipment is not the same as that which made the recording. If the play-back equipment speed varies periodically or cyclically ("wow" or "wow hash"), frequency-modulation distortion is generated. If the speed difference is constant, the frequency shift distortion effect is due to the multiplication of all the recorded frequencies by a fixed constant. If the play-back speed is greater than the recording speed, the multiplier constant is greater than unity and if lower, the constant is less than unity.

In this type of frequency-shift distortion, the duration of the signals is altered, but the harmonic relationships of complex-frequency signals' components are maintained.

Frequency-shift distortion may also be produced when the carrier-frequency at the transmitter end of the communications system differs from the carrier frequency at the receiver end of the system. In this case the distortion effect is due to either a fixed sum or difference frequency shift, depending upon whether the receiver carrier is higher or lower in frequency than the transmitter carrier.

In this type of frequency-shift distortion effect, the duration of signals is unchanged, but the harmonic relationships of complex signal's component frequencies are not.

Current electricity is known to have been used in Arabia some hundreds of years B.C. Jars which are unmistakably wet-cell primary cells have been discovered in ancient ruins. It is believed that they were used by metal artisans for a crude form of electro-plating, and that the method used was kept a trade secret by the craftsmen.

FOR SALE HARD-TO-GET ITEMS

All items are brand new, except where indicated. ALL are in PERFECT WORKING ORDER. In many cases, the parts alone total more than the price we are asking. Satisfaction guaranteed or your money back. ORDER FROM THIS PAGE. Use our convenient coupon. Include sufficient extra remittance for parcel post charges, otherwise order is sent express collect. Any excess will be refunded. All C.O.D. shipments require 20% deposit. No C.O.D. shipments on orders for less than \$5.00, if full remittance accompanies order deduct 2% discount. Send money order, certified check, or new U. S. stamps. No C. O. D.'s to foreign countries.

ULTRA MAGNET

LIFTS MORE THAN 20 TIMES ITS OWN WEIGHT

LITTLE GIANT MAGNET

Lifts 5 lbs. easily. Weighs 4 oz. Made of ALNICO new high-magnetic steel. Complete with keeper. World's most powerful magnet ever made. The experimenter and hobbyist will find hundreds of excellent uses for this high quality permanent magnet. Measures 1 3/4" x 1 1/4" Shp. Wt. 1/2 lb.

ITEM NO. 189 YOUR PRICE \$1.25



GENUINE MICROPHONE TRANSMITTERS

These are regular "telephone transmitters" of the type used on wall telephones. Taken from a large telephone supply company's overstock, these fine mikes offer a grand opportunity to obtain a splendid unit for little more than the price usually asked for a simple "microphone button."

The amateur experimenter and telephone mechanic will find a variety of uses for these excellent microphones. They work perfectly on 2 dry cells. Can be used on P.A. systems for voice transmissions, in call systems and intercommunications sets. With telephone receivers (radio headphones will do) they may be made into short-line telephone circuits, such as house-to-house or farm-to-farm "phone lines. You can use them to talk through your own radio, or as concealed dictaphone pick-up units for listening to conversations in a distant room or building. The telephone mechanic will find them useful replacements on battery-operated rural telephone lines.

THESE ARE NEW, GENUINE TRANSMITTERS, MADE BY KELLOGG, WETTER, ELECTRIC AND STROMBERG-CARLSON, excellent in appearance and operation. A remarkable value, and one seldom offered in these times. Shp. Wt. 1 lb.

ITEM NO. 180 YOUR PRICE \$1.50

AMAZING BLACK LIGHT!

Powerful 250-Watt Ultra-Violet Source

The best and most practical source of ultra-violet light for general experimental and entertainment use. Makes all fluorescent substances brilliantly luminescent. No transform of any kind needed. Fits a standard lamp socket. Made with special filter glass permitting only ultra-violet rays to come through. Brings out beautiful phosphorescent hues in various fine materials. Swell for amateur parties, plays, etc. To obtain unique lighting effects. Build

only. Shp. Wt. 1 lb. ITEM NO. 87 YOUR PRICE \$2.45

WATT HOUR METER

Completely overhauled and ready for immediate service. Designed for regular 110-volt, 60 cycle 2-wire A.C. circuit. Servicemen use it in their shops to check current consumption of sets, soldering irons, etc. Keeps coets down. If dismantled the parts alone would bring the price. The elaborate gear train could be used as a counter on machines of various kinds. Simple to install; 2 wires from the line and 2 wires to the load. Sturdily constructed in heavy metal case. 8 1/2" high, 6 1/4" wide, 5" deep. Westinghouse, G. E., or Wayne or other available make. Shp. Wt. 1 1/2 lbs.

ITEM NO. 33 YOUR PRICE \$7.45

LIMITED QUANTITIES! PROMPT SHIPMENTS!

It's Easy to order—Clip Coupon—Order from This Page—No Catalog Sent. MAIL TODAY—NOW!

(See Corresponding Ad. Page 500)

HUDSON SPECIALTIES CO.
 40 West Broadway, Dept. RC-5-44, New York 7, N. Y.
 I have circled below the numbers of the items I'm ordering. My full remittance of \$..... (include shipping charges) is enclosed (NO C.O.D. ORDERS UNLESS ACCOMPANIED WITH A DEPOSIT.) OR my deposit of \$..... is enclosed (20% remitted) by ship order C.O.D. balance. NO C.O.D. ORDER FOR LESS THAN \$5.00. (New U. S. stamps, check or money order accepted.)
 Circle Item No. wanted: 33 87 189 180

Name

Address

City

State

Send remittance by check, stamps or money order; register letter if you send cash or stamps.

MICROVOLTMETER FOR BIOLOGICAL WORK

(Continued from page 471)

A and B, representing (to any convenient scale) the quantities X and Y as shown. It will be found that the lines intersect AB very nearly at a single point C. Then set the variable tap on the 7.5-ohm resistor at a point which corresponds to C. (AC ohms from the left-hand side.) As a result, small variations in the filament voltage around 4.0 volts will produce but little motion of the galvanometer. Once completed, this adjustment need not be made again.

The adjustment for floating grid may have to be checked every time the instrument is operated, until it has run several hundred hours, as it has a tendency to drift. After sufficient aging this drift will practically disappear. An "aging run" at slightly higher than normal voltage will accelerate the stabilizing process.

For highest sensitivity (10 microvolts per millimeter of scale range), a Leeds and Northrup Type R galvanometer with a current sensitivity of approximately 3×10^{-9} amp/mm, a period of 2.7 seconds, and a critical damping resistance of 10,000 ohms has proved satisfactory. For many biological measurements, however, a galvanometer one-tenth as sensitive is sufficient.

Numbers of experiments made with this apparatus indicate that the living organism possesses an electrodynamic field, and that changes in the functioning of the physical organism are registered electrically. One interesting experiment was the measurement of electric potentials of a wounded area, in which it was shown that at different stages of healing, the wound varies from 9 microvolts positive to 7 negative with reference to a point selected on the healthy skin toward the head of the animal on which the test was made. The instant of ovulation in animals and effect of anesthesia on the E.M.F. of the nervous system have also been determined. Changes between the relative potentials of a seed and the growing root tip have been measured while the plant was in the process of sprouting.

Results have justified the formulation of an electrodynamic theory of life, the details of which depend only on further study and more detailed experiment.

Acknowledgment is made to the Yale Journal of Biology and Medicine, and to Dr. H. S. Burr, for material and assistance in the production of this article, and for kindly supplying the photographs used.

List of Parts

- A1—6 volt storage battery
- B1—45 volt heavy duty B battery
- C1—3 volt C battery
- C2—1½ volt C battery
- G—Galvanometer
- R1—10 megohm grid leak
- R2—10,000 ohm "Electrad" fixed resistor
- R3—6000 ohm "Electrad" fixed resistor
- R4—75/10 ohm semi-variable resistor
- R5—100,000 ohm "Electrad" fixed resistor
- S1—General Radio Type 339-B double pole, double throw switch with amber substituted for bakelite insulation
- S2—Double pole single-throw toggle switch
- S3—Single pole single-throw toggle switch
- S4—General Radio Type 339-B, double pole, double-throw switch
- T1 and T2—RCA 112A radio tubes with bases removed
- V—0-6 voltmeter
- V1—General Radio variable resistor 20 ohms, type 214-A
- V2—General Radio variable resistor 2500 ohms, type 214-A
- V3—General Radio variable resistor 25 ohms, type 301
- V4—General Radio variable resistor 20,000 ohms, type 314-A
- V5—General Radio variable resistor 1,000 ohms, type 214-A
- V6—General Radio variable resistor 400 ohms, type 214-A
- V7—General Radio variable resistor 20 ohms, type 214-A

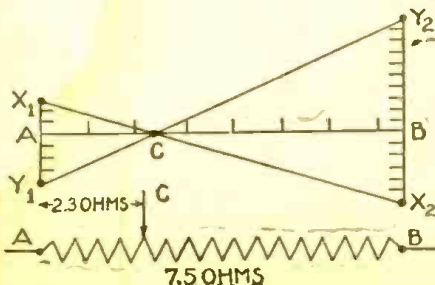

Fig. 2—Compensating for voltage fluctuation.

ELECTRICITY

For Any Job Anywhere

For a dependable source of electricity on projects remote from commercial power, Onan Electric Plants are proven leaders in the field. More than half of the Armed Forces' total requirements for Power Plants are built by Onan.

Gasoline driven—single-unit . . . Compact design . . . sturdy construction . . . Suitable for mobile, stationary or emergency applications.

Over 65 models, ranging in sizes from 350 to 35,000 watts. 50 to 800 cycles, 110 to 660 volts, A.C. . . . 6 to 4000 volts, D.C. . . . also dual A.C.-D.C. output types.

Descriptive literature sent promptly on request. D. W. ONAN & SONS, 733 Royalston Ave., Minneapolis, Minn.

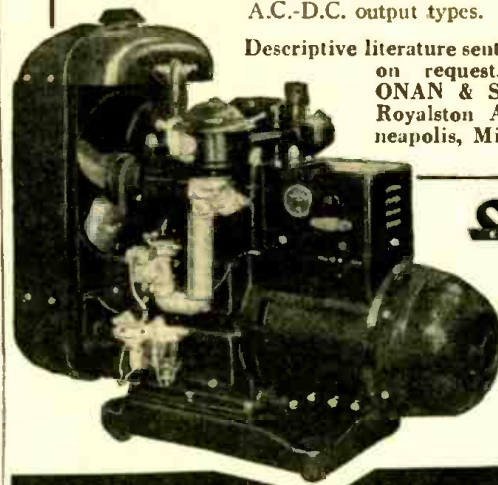

ONAN
ELECTRIC PLANTS



Awarded to each of the four manufacturing Plants of D. W. Onan & Sons.

"THE INDUCTANCE AUTHORITY"

By EDWARD M. SHIEPE, B.S., M.E.E.

THE ONLY BOOK OF ITS KIND IN THE WORLD. "The Inductance Authority" entirely dispenses with any and all computation for the construction of solenoid coils for tuning with variable or fixed condensers of any capacity, covering from ultra frequencies to the borderline of audio frequencies. All one has to do is to read the charts. Accuracy to 1 per cent may be attained. It is the first time that any system dispensing with calculations and correction factors has been presented.

There are thirty-eight charts, of which thirty-six cover the numbers of turns and inductive results for the various wire sizes used in commercial practice (Nos. 14 to 32), as well as the different types of covering (single silk, cotton-double silk, double cotton and enamel) and diameters of $\frac{1}{8}$, $\frac{1}{4}$, 1, 1½, 1¾, 2, 2½, 2¾, 2⅞ and 3 inches.

Each turns chart for a given wire has a separate curve for each of the thirteen form diameters.

The book contains all the necessary information to give the final word on coil construction to service men engaged in replacement work, home experimenters, short-wave enthusiasts, amateurs, engineers, teachers, students, etc.

There are ten pages of textual discussion by Mr. Shiepe, graduate of the Massachusetts Institute of Technology and of the Polytechnic Institute of Brooklyn, in which the considerations for accuracy in attaining inductive values are set forth.

The book has a flexible fiber cover, the page size is 9 x 12 inches and the legibility of all curves (black lines on white field) is excellent.

Order from your dealer or direct—\$2.50

GOLD SHIELD PRODUCTS

350 Greenwich St. (Dept. R.C.5), New York City



have you sent for your SHURE REACTANCE SLIDE RULE?

Thousands of engineers and technicians find the Shure Reactance Slide Rule helpful in radio computations. Simplifies problems in resonant frequencies, circuits, inductances, condensers. Range 5 cycles per sec. to 10,000 megacycles. Complete with instructions. Send 10c in coin to cover handling.

SHURE BROTHERS
225 W. Huron St., Chicago

Designers and Manufacturers of Microphones and Acoustic Devices



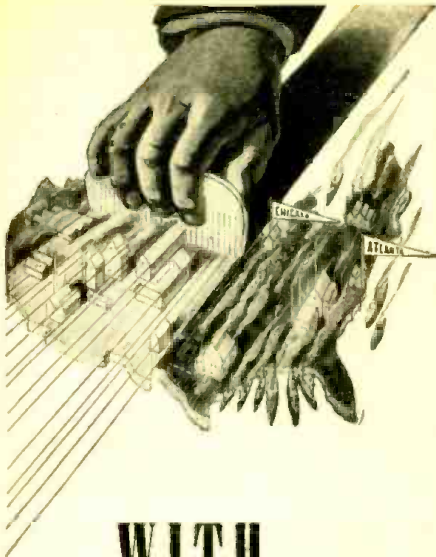

WITH
A
FINE
COMB

Ever vigilant, Lafayette Radio Corporation's tracers fine-comb the field for radio and electronic components and equipment. We deal only with top-flight manufacturers, so quality and performance are assured. And the accent throughout is on Service. Wherever possible, same-day deliveries are maintained. If technical and priority problems perplex you—we've got 25 years of experience behind us to help pull you through. Call, write, wire, or teletype—either to Chicago or Atlanta. Orders, in any quantities, filled from both cities. Note: we build equipment to specifications.

If you live in or near one of the 35 blood bank center cities, call the Red Cross today for an appointment..... your blood is needed.

Lafayette Radio Corp.
901 W. Jackson Blvd. CHICAGO 7, ILLINOIS
265 Peachtree Street ATLANTA 3, GEORGIA

POWER OUTPUT TUBES

A very commonly used output tube is the 50L6, and it is very scarce indeed at present. It may be replaced with a 35L6 if additional resistance in series with the 50L6 filament circuit is added—100 ohms at 5 watts to drop 15 volts—which is the difference voltage between the 50L6 and 35L6. The type 25L6 may be used by altering the filament circuit. A typical change is illustrated in Fig. 2. The 50L6-GT, 35L6-GT, 25L6-GT, 25L6 may also be used. Other suitable substitutes are the 6W6-GT and 70A7-GT. Many of the other output tubes might be used, but generally have radically different load resistance requirements and different mutual conductances.

The 35L6 may be replaced with any of the above types. The 6F6 may be replaced with a 6F6-G, 6F6-GT, 42, 41, 6K6, 6K6-G, 6K6-GT. The 6L6 may be replaced with a 6L6-G. If any other tube is used, replacement of the output transformer and adjustment of the bias may be required. Don't simply substitute a tube in place of the 6L6. Study the circuit and tube characteristics first, and then make whatever changes are necessary. A 6V6, 6V6-G or 6V6-GT can be used, but the circuit must be modified for correct bias and a new output transformer installed.

In some General Electric and Zenith receivers the direct coupled type of audio amplifier is used. If a replacement tube of the right variety is unavailable, a type 6F6 may be substituted for the direct coupled 6AC5-G, eliminating both the output tube and the 6P5-G driver. In small sets using the 25AC5-G, the 25L6 may be substituted.

In making the change shown in Fig. 3, a new output transformer is not required, because the load resistances of the original tube and 6F6 replacement are identical. This also holds true for the 25L6 and 25AC5-G. It is interesting to note that the D.C. amplifier operates with a positive grid on the output tube. The grid becomes more positive or less positive in the presence of an input signal, causing a variation in plate current and development of a signal voltage in the plate circuit. Most class A amplifiers operate in such manner that the grid becomes less negative or more negative in the presence of the input signal. The variation in the cathode voltage across the bias resistor of the 6P5-G, of course, results in a variation in the grid potential of the output tube, since the resistor is in series with the grid circuit of the tube.

Another type of tube which may be scarce on occasion is the 47. It can be replaced with a 2A5.

RECTIFIER REPLACEMENTS

The 35Z5 is a scarce rectifier. It may be replaced with the 35Z5-GT, 25Z5, 25Z6, 25Z6-GT, 117Z4-GT, 35Y4, 35Z3, 35Z4-GT, 45Z5-GT, 50Z6, and it would be possible to use a 12Z3 if space permits. The 35Z5 has a tapped filament, a pilot lamp being connected between terminals 2 and 3. If this section burns out, a 40 ohm 5 watt resistor may be shunted across terminals 2 and 3 at the socket, and if the tube is otherwise all right it will still be usable.

The 25Z5 may not fit in some sets because of the relatively large bulb size. In addition, it requires a filament circuit change for a .3 amp. tube. The 25Z6 and 25Z6-GT require a filament circuit change. As a matter of fact, if any rectifier is used (except 35Y4 or 45Z5-GT) as a replacement for the 35Z5 the filament circuit must be modified some-

what, because the replacement tube does not have a tapped filament. The original circuit of Fig. 1, modified to use a 25Z6-GT, is shown in Fig. 4. The filament change for the .3 amp. rectifier may be made in several ways. Typical circuits are shown in Fig. 5-a and Fig. 5-b. The 35Y4 has a .15 amp. heater and no change in the cir-

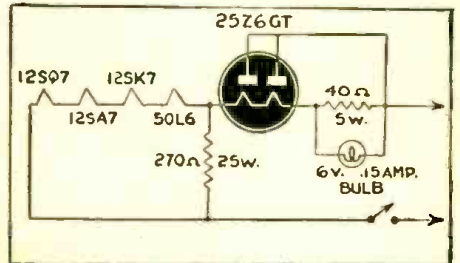

Fig. 4—A .3-amp. tube may be inserted in a .0.15-amp. filament circuit as shown above. Resistance of the 25-watt unit is 530 ohms.

cuit is required, as this tube also has a tapped filament. If a rectifier of the .15 amp. type is used, without a filament tap, the circuit of Fig. 6-a may be set up. The 35Z3 can be used. The plate voltage will be dropped by a negligible amount using the series pilot lamp and shunt resistor of 40 ohms and 5 watts. If the 117Z4-GT is used in place of the 35Z5, the circuit of Fig. 6-b may be employed. A 2 volt, .06 amp. bulb is used with a shunt resistor.

In many receivers the 5Y4-G is used. In Philco sets having the rectifier socket on top of the transformer, a 5Y3-G can be used by taking the casing off the transformer to get at the pin connections of the socket. The wiring then can be changed so that either a 5Z4 or 5Y3-G can be used in place of the original 5Y4-G. It is also possible to use the change in reverse in other sets—to substitute the 5Y4-G for either the 5Y3-G or 5Z4, provided the socket connections are changed. If the sock-

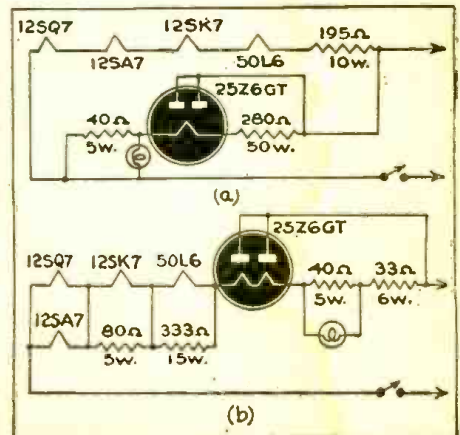

Fig. 5—Two other methods for using .0.3-amp. tubes in circuits designed for .0.15 amperes.

et can be removed readily, a four prong socket for a type 80 tube can be installed, the 80 being equivalent to the types named above. The 80 seems to be about the longest lived rectifier of them all. In the case of the voltage doubling rectifier 50Y6, a single plate rectifier obviously cannot be used as a replacement. A type 25Z5 may be used as a substitute provided a filament circuit change for a .3 amp. tube is made. A 25Z6, 25Z6-GT, 12Z5, 25Y5, 25Z6-MG and 50Z6 could also be used. The 25Z6 and 25Z6-GT

require a filament circuit change for a .3 amp. filament. The same holds true for the 25Y5 and 25Z6-MG. The 50Z6-G has a 50 volt, .3 amp. heater and also will require a filament circuit modification.

DIODE DETECTORS

The 6H6 may be scarce on occasion. A replacement type is the 6H6-GT. The 6H6-G can be used if there is sufficient space. The loktal equivalent, 7A6, will require a new socket and filament circuit change if the set is A.C.-D.C. with series filaments. If straight A.C. the difference in current (.15 amp. for the 7A6 and .3 for the 6H6) will be unimportant. The 12H6 has a 12 volt, .15 amp. filament and may be replaced with the 6H6 if the filament circuit is modified for a .3 amp. tube, or with a 7A6 with less trouble. The 7A6 job

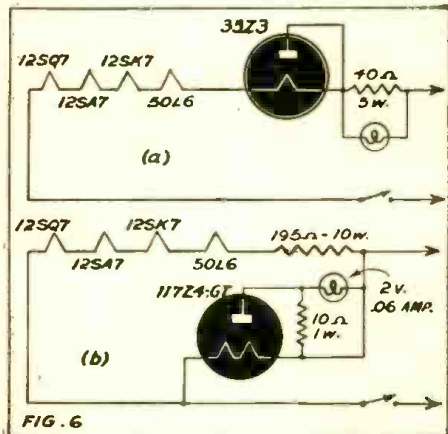

Fig. 6—How the pilot light may be retained.

will require additional resistance of 40 ohms at 5 watts hooked in series with a filament. If space is sufficient, a diode combination tube, such as the 12SQ7, or 6SQ7 may be used, the triode section being disregarded.

It is also possible, in some cases, to use a triode converted to a diode by tying the plate and grid together. The 6J5G, as a matter of fact, is used as a diode in many Philco sets. Some small receivers also use the 76 as a diode power rectifier to supply B current. Such tubes may be replaced with equivalent rectifiers, such as the 25Z5, 35Z3, etc., provided proper changes are made in the filament circuit. It is NOT such a hot idea, as some have indicated, to use a 117Z6 full wave rectifier as a replacement for the 6H6. Neither is it a good idea to use a tube such as the 6H6 as a power rectifier for A.C.-D.C. sets or to power battery portables on A.C. lines. A standard power rectifier should be used for such service.

The calculations necessary are simple, and Ohm's Law will suffice for all the changes described.

ELECTRONIC DIAGRAMS

(Continued from page 476)

junction with photographs or installation drawings. (Refer to figure 2.)

With the present trend toward the use of compact power supplies, dynamotors and motor generator units to supply the greater power requirements of the newest types of commercial radio equipment, it is almost essential for a radio technician to not only understand the principles of power generation, but to be able to interpret electrical power supply drawings and schematics.

Here again confusion crops up if graphical symbols are incompletely or improperly understood.

Table 3 illustrates the meanings of the electrical power supply graphical symbols usually used in conjunction with radio circuit schematics.

Wiring symbols, as used in electrical work, vary a good deal from the symbols used in electronics. Table 4 shows the symbolism for electrical wiring occasionally encountered by radio technicians.

In every case when drawing or using a schematic, use the proper type of symbol for the component designated and the correct class of symbolism for the project at hand.

Radio graphic symbols for radio and electronic work; power apparatus symbols for power supplies, and electrical wiring symbols for electrical wiring diagrams, should be used.

The move now on foot to standardize electronic symbols is very encouraging. There can be little doubt, however, that

even if successful, the immediate result will be to increase the confusion. Many conservatives from both the power and communications fields will be slow to come over to the new system, and there will be a period in which we will have to contend with three systems instead of two.

The most important fact to bear in mind is, to standardize your system of radio graphical symbolism and schematic design.

If you draw diagrams for both power and communications people, make sure that each type of diagram follows its proper set of symbols and will be correctly read.

Canada has appointed a Committee on Broadcasting to investigate that country's radio set-up, report on complaints—chiefly by independent broadcasters in competition with the government's Canadian Broadcasting Corporation and make suggestions for future improvement.

FREE—if you subscribe now to

RADIO-CRAFT

AND POPULAR ELECTRONICS

PARTIAL CONTENTS

RADIO-ELECTRONIC REFERENCE ANNUAL

ELECTRONIC THEORY AND GENERAL PRACTICE

Is thoroughly covered in this book in easy-to-grasp language. Among the articles on this subject are: What You Should Know About Electronics—Electronic Tubes for Servicemen—The Electronic Solovox—Its theory and action—and The Photoelectric Phonograph Pickup, the principles underlying its operation.

ELECTRONIC DEVICES YOU CAN BUILD

Among the interesting and easily constructed devices selected are the following: Compact Hearing Aid—Duplex Automatic Key and Code Machine—Electronic Relay—Camcorder and Light Operated, High Frequency Radiotherapy, a complete home apparatus—and many other timely types of electronic apparatus.

RADIO CONSTRUCTION

Many well-illustrated, how-to-do-it articles, such as: Phono Oscillators, several types, adapted to playing records through your radio with a simple record player—T.R.F. Sets—Superheterodynes—Power packs for Portable Receivers, making it possible to use your battery portable on the electric light line—A two-tube Super Midcut Amplifier, which is a palm-of-the-hand public address system—and many others.

SOUND AND RECORDING

Including detailed instructions on constructing: High-Fidelity Amplifier—Exponential Horn with Perfect reproduction down to 50 cycles—Electronic Expander-Compressor—Also the Roberson Technique—Semi-Pro Recording—Electronic Bass—and Treble-Expanding Circuits—Equalizers, etc.

TEST INSTRUMENTS

A complete line including: A Tube Checker with universal hookup; can check any tube regardless of the prong to which its elements are brought out—Compact Multimeter; 18 ranges of voltage, current and resistance on an 11-point, 2-gang scale—A Three Tube Signal Tracer, capable of checking R.F., I.F., and audio circuits—Condenser Analyzer which measures both capacity and checks leakage—and an Electron-Ray Voltmeter which diagnoses with hand-to-get millimeters, using a 6E5 tube instead.

SERVICING

Articles on servicing supply a multitude of methods and useful ideas, including: Dynamic Testing with Signal Generator—Modernizing a Test Set—Calibrated UHF Oscillator—And countless other hints for ironing out kinks in your servicing problems.

FREE

Are you asking yourself: "What's next in Radio and Electronics?" What mysterious inventions are brewing in research laboratories? What effect will these wartime secret inventions have on peacetime conditions? Will the scientists take me into new, unfamiliar fields, requiring special technical education?

Keep Posted With Radio-Craft

Radio is once again at the crossroads! All must become students again of a science that has experienced a marvelous rebirth through **ELECTRONICS**. The question about the near and distant future now racing through your mind will be answered step by step in the forthcoming issues of **RADIO-CRAFT**.

You Need This Free Reference Annual, Too!

You can't plan intelligently ahead—you can't grasp the new until you have thoroughly mastered the tried and accepted present-day radio developments. And that is where the **REFERENCE ANNUAL**, comes to your aid. This fact-packed book is THE radio man's digest. It's the spark that bridges the gap between the **RADIO-ELECTRONIC WORLD OF TODAY** and the **COMING POST-WAR WORLD**.

And think of it—you can get it absolutely free and postpaid by subscribing to **RADIO-CRAFT** now—but you must act quickly as war-paper shortage compels us to limit the printing. If you are already a subscriber we can extend your subscription.

1944

IN ALL ITS PHASES

TIME LIMIT OFFER

RADIO-CRAFT WITH FREE COPY RADIO-REFERENCE ANNUAL

1 Year \$2.50
2 Years \$4.50
3 Years \$6.00

If you are already a subscriber we can extend your subscription. If you will check "Extension" box.

CUT OUT AND MAIL

Be sure to use coupon or mention Free Reference Annual when ordering.

Gentlemen:

I want to take advantage of your Special Time Limit Offer for your **RADIO-ELECTRONIC REFERENCE ANNUAL—1943-1944**, which you will send me **ABSOLUTELY FREE** and **PREPAID** in connection with my subscription to **RADIO-CRAFT** and Popular Electronics for the period checked below.

I enclose my remittance of \$.....

1 Yr. \$2.50 2 Yrs. \$4.50 3 Yrs. \$6.00

This is a new order Renewal Extension

Name Please print clearly

Address

City State

Postal Dist. No. (if any)

(Canadian and Foreign subscriptions 5c extra per copy. Send by International Money Order.)

FOR SALE HARD-TO-GET ITEMS

All items are brand new, except where indicated. ALL are in PERFECT WORKING ORDER. In many cases, the parts alone total more than the price we are asking. Satisfaction guaranteed or your money back. ORDER FROM THIS PAGE. Use our convenient coupon. Include sufficient extra remittance for parcel post charges, otherwise order is sent express collect. Any excess will be refunded. All C.O.D. shipments require 20% deposit. No C.O.D. shipments on orders for less than \$5.00. If full remittance accompanies order deduct 2% discount. Send money order, certified check, or new U. S. stamps. No C. O. D.'s to foreign countries.

THE MAGIC ELECTRIC WELDER



Here is one of the most compact, practical welders we have ever seen. Anyone can use it for shop, farm and home repairs. **WELDS. BRAZES. SOLDERS.** ALL METALS. ANYONE CAN OPERATE IT. Repairs steel, cast iron, aluminum, brass, copper, bronze, etc. Complete with power unit, frame and metallic arc attachment.

ments. (really two welders in one). Carbons, fluxes, rods, mask included. Just plug in in any electric outlet, 110 volts AC or DC. For hobbyist or professional.

GET IN ON THE GREAT WELDING BOOM. This fine set quickly teaches you welding. Low cost to operate—about 5¢ an hour. COMPLETE SAFETY is assured. No fumes with this outfit. SET COMES COMPLETE—no hook else to buy. Used by the U. S. Navy, American Tel. & Teleg. Co., Eastman Kodak Co., Bell Laboratories, etc. BRAND NEW OUTFIT. Guaranteed for one year. Complete simple instructions with each set. **ITEM NO. 158 \$19.95**
YOUR PRICE

WESTERN ELECTRIC BREAST MIKE

This is a fine light-weight aircraft carbon microphone. It weighs only 1 lb.

Mike comes with breastplate mounting and has 2-way swivel adjustment so that it can be adjusted to any desired position. There are 2 worn straps. One goes around neck, the other around chest straps can be snapped on and off quickly by an inkstuous arrangement.

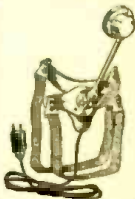

This excellent mike can be adapted for home broadcasting or private communication systems. By dismantling breastplate, it can be used as desk mike.

Comes complete with 6-foot cord and hard rubber plug. Finished in sherdardized plate, non-rustable.

THIS IS A BRAND NEW MIKE. IT HAS NEVER BEEN SOLD AT SUCH A LOW PRICE BEFORE. ORIGINAL LIST PRICE \$15.00. Shipping weight, 2 lbs.
ITEM NO. 152 \$2.55
YOUR PRICE

POWERFUL ALL-PURPOSE INDUCTION MOTOR

IDEAL FOR EXPERIMENTERS—101 USES



Sturdily constructed to precision standards, this self-starting shaded pole A.C. induction motor is powerful enough for a number of uses. Some of these are: Automatic Timing Devices, Current Interrupters, Electric Fans, Electric Chimes, Window Displays, Photocell Control Devices, Electric Vibrators, Small Grinders, Buffers and Polishers, Miniature Pumps, Mechanical Models, Sirens, and other applications.

Consumes about 15 watts of power and has a speed of 3,000 r.p.m. When geared down, this sturdy unit will constantly operate at 18 inch variable loaded

with 200 lbs. dead weight—THAT'S POWER!
Dimensions 3" high by 2" wide by 1 3/4" deep; has 4 convenient mounting studs; 3/16" diameter, and runs in self-aligning oil-retaining bearings. Designed for 110-220 volts, 50-60 cycles, A.C. only.
ITEM NO. 147 \$1.95
YOUR PRICE

LIMITED QUANTITIES! PROMPT SHIPMENTS!

It's Easy to order—Clip Coupon—Order from This Page—No Catalog Sent.

(See Corresponding Ad. Page 498)

MAIL TODAY—NOW!

HUDSON SPECIALTIES CO.

40 West Broadway, Dept. RC-5-44, New York 7, N. Y.

I have circled below the number of the items I'm ordering. My full remittance of \$..... (include shipping charges) is enclosed. (NO C.O.D. ORDERS UNLESS ACCOMPANIED WITH A DEPOSIT.)

OR my deposit of \$..... is enclosed (20% required). ship order C.O.D. balance NO C.O.D. ORDER FOR LESS THAN \$5.00. (New U. S. stamps, check or money order accepted.)

Circle Item No. wanted 147 152 158

Name

Address

Please Print Clearly

City

State

Send remittance by check, stamps or money order; register letter if you send cash or stamps.

ELECTRONIC RAT TRAP

(Continued from page 463)

might have a repellent effect upon future captures. The inventors decided that capture must be effected at one point in the trap and death in another!

Caught in the tunnel of the automatic trap, the rat finds one means of egress—an easy one. A small ramp leads upwards to a chamber above. He scurries up the ramp, enters the chamber and, stepping upon the floor, makes an electrical contact, which drops the door behind him, barring any return.

Undoubtedly perturbed at this point, the rat proceeds to take the only route left open to him, a small passage leading to the six-stalled death chamber. En route, he steps upon a switch plate which not only rises behind him to block any retrogression but also—inasmuch as this particular rodent's end is near—sets in operation a release mechanism that opens up the tunnel "downstairs" for the next victim. The rest of the tale is short and bitter (for the rat). He has no alternative but to choose one of the six innocent-looking, electrically-

charged stalls. In he creeps and—presto!—from top, bottom and both sides he receives his lethal, 110-volt charge—not enough to burn or sizzle him, but plenty for the kill.

The whole operation, from start to finish, takes far less time than it does to read about it.—Only five seconds, from "electric eye" to electric shock, and Valhalla! The death chamber is removable, like a drawer, so the corpses can be dumped in a sanitary manner without anyone having to touch them.

According to Vincent and Stanton, the death of one rat has absolutely no influence upon those that are to follow. Not until they had electrocuted more than a thousand rats were they willing to accept the proof as final. And thus it was with every detail of the trap's evolution—experiment, test, retest, *prove!* Biggest one-night haul, for one trap, thus far, is 77 dead rats, but "scores" of 40 to 50 per trap are not unusual.

ELECTRONIC DEVICE CHECKS GLAMOUR

GLAMOUR may or may not be rationed, but as a precautionary step a scientist of the R. K. Laros Silk Company, Bethlehem, Pennsylvania, has invented a meter which accurately computes the available supply of this elusive product. Electric and gas meters may be read with scientific precision; similarly, this unique device grades glorified girls in terms of the sheerness of their hosiery or the translucence of delicate fabrics worn.

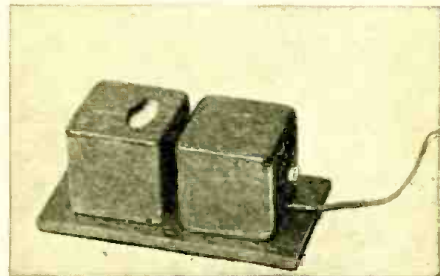

Sex appeal may write its own automatic records of glamour, but Jerome Barney, inventor of the gadget being described, apparently thinks that by grading hosiery and other sheer fabric, before they are put on, enchantment is reduced to a science. This instrument determines the exact sheerness of nylon or rayon hosiery, as well as the translucence of a new dress. Strangely enough, living models are not used in these tests but a frame or dummy has suspended on it a layer of stocking-leg fabric or sheer cloth.

Through this fabric, resting on the framework, is sent a concentrated beam of light. A meter, positioned on the other side of the set-up, intercepts a portion of the light passing through, converting it into electric current. This, in turn, moves a needle or pointer bearing graduated numbers across the face of a dial.

Translucence of milady's degree of glamour is graded on a scale from zero (for wool hosiery or other fabric lacking sex appeal) to a substantial number for some of the cobweb black lace sheerness, which makes two-thread hosiery appear like a mirage or the essence of nothing. This triple sheerness is not seen realistically by human eyes and it may be confused with bare legs or painted "pretties."

This sheerness meter is portable, being as compact as a camera or field radio receiving set. It is comprised of a small box—insulated against daylight—and contains an electric-light bulb, a light-sensitive unit such as an electric eye, a light meter, a mirror for reflecting the light, a battery, a graduated dial, and a support for the hosiery or other fabric.

This glamour grader determines the sheerness of all tints and hues, although its standard is based solely on sheerness, rather than color or shade. This device can

be operated by an inexperienced person, whereas, heretofore the sheerness of material has been determined by comparative appearance and personal inspection, or by a magnifying glass, which made observable the threads per inch, yarn diameters, courses per inch, stitches per inch, and loop formation.—S. R. W.

HEROES OF THE HOME FRONT

IN recognition of extreme valor, the Western Electric Co. recently awarded the Theodore N. Vail medal in bronze to a number of employees who had distinguished themselves during an emergency in the vacuum tube plant.

At fifteen minutes past midnight on the morning of November 30th, 1943, an explosion rocked the company's Vacuum Tube Shop at 395 Hudson Street, New York City. Heavy steel doors were ripped from their fastenings, walls were crushed while broken glass and debris littered the streets for blocks around. Gas leaking from hydrogen tanks on a ground floor loading platform had ignited and caused the disaster.

Mr. DeLyon, supervisor of the hydrogen equipment, with three fellow employees, Messrs. Gerlach, Mohrhoff and Rom, entered the gas room immediately upon learning of the initial trouble. Again and again the escaping gas drove them out but with full knowledge of the extreme hazard involved they persisted in an attempt to avert the tragedy. All were injured by the explosion and Mr. DeLyon lost his life. The medals were issued to all four of these heroes of industry.

MATHEMATICS FOR RADIO

Two volumes, prepared for home study. Book I (314 pp.) covers the algebra, arithmetic, and geometry; Book II (329 pp.) covers the advanced algebra, trigonometry, and complex numbers necessary to read technical books and articles on radio.

MAEDEL PUBLISHING HOUSE Room 117
593 East 38 Street, Brooklyn, New York

Send me **MATHEMATICS FOR RADIO AND COMMUNICATION** as checked below. I enclose payment therefor with the understanding that I may return the book(s) within 5 days in good condition and my money will be refunded.

Name

Address

- Book I at \$3.75 plus 6c postage
- Book II at \$4.00 plus 6c postage
- Books I and II at \$7.75 postage prepaid

Foreign and Canadian prices 25c per volume higher

The first condenser is charged to a potential determined by the neon tubes. The discharge of the second condenser serves to energize a relay which controls the opening of the camera shutter.

Below is the phototube circuit which predetermines the exposure time. The amount of charge held by the condensers will depend upon the conductivity of the photo-tube which in turn depends upon the amount of light present.

Microsecond electronic photography has already been in use several years, having been perfected by Dr. Charles Slack of the Westinghouse Lamp Division. In place of ordinary illumination, Dr. Slack employs a special cold-cathode X-ray tube that may have as many as 2000 amperes passing it in 1/1,000,000 second. Such high current produces rays of high penetrating power and high actinic value. A number of industrial uses have already been found for the type of investigation made possible by such equipment.

Fig. 9 illustrates the circuit used. The rectifiers (A) charge a bank of condensers to 90,000 volts. This high voltage is applied between the cold cathode and the anode of the tube in series with a gap (B). The control tube (C) which operates when the switch (B) is opened, induces more voltage in the gap circuit and produces a heavy discharge across this member. In this way, the full voltage of the condenser bank is applied between the cathode and anode of the X-ray tube.

Microsecond photography is not only possible with equipment of this sort but it may also be X-ray photography. Even high speed bullets propelled by the new explosives may be caught dead in their tracks while they are in the act of penetrating wood, steel or other material.

Electronic stroboscopic photography is rapidly becoming an industrial tool of the first magnitude. It permits the study of moving machine parts at high speed and also the study of many factory operations conducted by hand. Inexpensive stroboscopic cameras operated electronically will soon be supplied to time study engineers throughout the country.

Recently a great deal of work has been done on a camera provided with an electronically operated "lens motor." It is known that the human eye, due to rapid compensating adjustments in the cornea, is able to provide depth of focus to any scene. Not so with the camera, the depth of focus of even the best lens being extremely shallow. Unless all objects are mounted in or close to the same plane, some will be out of focus and some will be in focus.

The electronic-lens camera overcomes this shortcoming in a very large measure by having one double concave lens mounted on the moving element (coil) of a modified dynamic speaker motor. Thus is high speed electro-dynamic movement brought to the lens which is caused to bring into focus distant as well as nearby objects.

Photography and electronics again come very close together in the moving picture industry where electronic (gaseous) illuminators of special construction are used in recording sound on the edge of moving picture film according to the "variable density" method. Amplified sound reaching the recorders from the microphones, in place of entering a loud-speaker, enters a gaseous tube so constructed that variations in the emitted light take place when the modulated current passes through. Thus are

modulations in the emitted light made possible and this light, in turn, is recorded on the edge of the film.

The wire transmission of news photographs would be impossible were it not for certain electronic devices, principally vacuum tube amplifiers. The synchronizing systems of a number of the methods employed in such transmissions are also basically electronic.

Photoelectric exposure meters have been used extensively for the past ten years, although they could have been used twenty-five years ago when the first commercial photoelectric cells began to appear. However, such cells generated so little current that it would have been necessary to have used them with some sort of an amplifier. The modern self-generating dry-disc cells generate as much as five milliamperes or more and this current is fed directly to a D.C. milliammeter calibrated in suitable units. The photoelectric exposure meter is highly accurate and although more expensive than the older, non-electronic devices, is widely employed.

Some years ago, the Eastman Kodak Company brought out a camera with an electronically controlled shutter opening. The camera carried a dry disc type of photocell. This was connected electrically to a sensitive mechanism that regulated the amount of light entering the lens. The latter was actuated by the small amount of current generated by the cell. It was so sensitive, however, that the camera could not withstand a great deal of abuse, and the equipment had to be withdrawn from the market. Some day it will return in a highly perfected form and exposure in photography will be reduced to a purely automatic affair; every click of the shutter guaranteeing a perfect exposure.

Although not a purely electronic device, the Kerr cell still holds great promise in photo-electronic investigations of the future. This cell is really a light valve that may be used to turn light "on" and "off" by either permitting or preventing the passage of a light beam through liquids having certain electro-optical properties. Two parallel metal plates, with carbon disulphide or nitrobenzene between, form a special condenser. These liquids, when subjected to electric stress, as would be the case when a potential was applied to the plates, will rotate the plane of the beam of polarized light passing through the liquids. The light beam employed is first passed through two suitably designed and arranged prisms, which polarize it. Thus application of electric potentials to the plates of the cell may make it a good conductor of the light rays, or stop them entirely.

The young student electronist will do well to study the action of the Kerr cell, which has already been called into use in a number of electronic applications.

Electron microscopy will lead to great improvement in aluminum alloys, it is believed by research scientists. Some changes which take place in the structure of these alloys cannot be studied with optical microscopes. The electron microscope is able to investigate the fine structure of metals without difficulty, giving scientists an opportunity to find out the results of certain alloys and processes and thus making further progress possible.



Our Headphones are used by the United States, Canadian, New Zealand and South African Governments as well as other Governments not directly in the war.

Headset Headquarters

Scientifically Built Heavy Bar magnets greatly increase their efficiency.

Folder R-5 illustrates rugged, unusually sensitive, dependable Cannon-Ball Headsets. Write

C. F. CANNON COMPANY
SPRINGWATER, N. Y.

RADIO AND ELECTRONIC DEVICES



BURSTEIN-APPLEBEE CO.
1012-14 McGee St. Kansas City, Mo.

HIGH EFFICIENCY results in Sound National Defense that is why NATIONAL DEFENSE SOUND SYSTEMS are equipped with University Reflex HIGH POWER LOUDSPEAKERS UNIVERSITY LABS. 228 VARICK ST. N. Y. C.



USED Correspondence Courses Complete HOME-STUDY Courses and self-instruction books, slightly used, rented, and exchanged. All subjects. Satisfaction guaranteed. Cash paid for used courses. Full details & 84-page illustrated bargain catalog free. Write now.

NELSON CO., 321 So. Wabash Ave., Dept. 210, Chicago, Ill.

**SOME ENGINEERS
WE DON'T WANT
AT NATIONAL UNION**

★

Let's make it plain. There are a lot of engineers **WE DON'T WANT**. We have an outstanding group of engineering specialists who are **GOING PLACES**. They're thinkers, doers, practical dreamers. We're proud of them. **WE DO WANT** more engineers to join them but they have to be fellows who measure up. If you're not just trying to hit a high spot today. If you want to get into the exciting war work we're doing now and ride along on our great peace time electronic tube band wagon—**THIS IS YOUR BIG OPPORTUNITY**. We are adding to our staff engineers who specialize in

**ELECTRONIC TUBES
PRODUCTION
DEVELOPMENT
MEASUREMENTS
PHYSICS
ELECTRICITY
TRANSMITTING TUBES**

Our laboratories in Newark, N. J., offer ideal working conditions. We prefer that you have a degree in electrical engineering, physics, chemistry or mathematics—your experience, however, may be sufficient.

Why don't you find out whether you're one of the engineers National Union **DOES WANT**. Write and tell us about yourself or Phone **HUmboldt 2-5252, Ext. 72**, for appointment.

★

**NATIONAL UNION RADIO
CORPORATION**

50 Spring Street, Newark, 2, N. J.



ENGINEERS

Are You Concerned With ? YOUR POST WAR FUTURE ?

The Federal Telephone & Radio Corporation, the manufacturing unit of the International Telephone & Telegraph Corporation with its multiple business activities extending to all parts of the civilized world, will accept applications from experienced men for immediate employment with almost limitless post war possibilities. These positions, should interest those with an eye to the future and whose interest lies in forging ahead with this internationally known organization whose expansion plans for post war are of great magnitude covering all types of radio & telephone communications. Advancement as rapid as ability warrants. Majority of positions are located in the New York area!
Essential workers need Release Statement.

We need the following personnel! Men with long experience or recent graduates considered.

- **ENGINEERS**
ELECTRONICS
ELECTRICAL
RADIO
MECHANICAL
CHEMICAL
TRANSFORMER DESIGN
- **SALES AND APPLICATION ENGINEERS**
PHYSICISTS
DESIGNERS
DRAFTSMEN
TOOL DESIGNERS
TECHNICAL WRITERS

Look Ahead With Federal!

If inconvenient to apply in person, write letter in full, detailing about yourself, education, experience, age, etc., to Personnel Manager.

FEDERAL TELEPHONE & RADIO CORP.

39 Central Avenue

EAST NEWARK

NEW JERSEY

RADIO TECHNICIANS AND ENGINEERS

We have interesting openings available for experienced radio men genuinely interested in improving themselves in this field.

Minimum requirements constitute amateur or servicing experience. Men with broader experience will assume more responsible positions along the lines of electronic research and development.

These openings afford better than average opportunities for really capable men anxious to become associated with a progressive organization which has sound post-war prospects.

Send a brief letter outlining your experience, education, and salary desired. Early interviews for qualified applicants will be arranged in New York, Boston, or Salem.

SYLVANIA ELECTRIC PRODUCTS, INC.

Industrial Relations Department

254 Essex St.

SALEM

MASS.

OPENING for MOTOR ENGINEER

Engineer with electric motor experience, ingenious, and with sound basic engineering knowledge, to be assigned unhampered to very interesting project. Location East. Medium sized concern with established reputation in electronics field. Salary commensurate with ability.

BOX 405

c/o RADIO-CRAFT Magazine
25 West Broadway, New York 7, N. Y.

This Fast-Growing Company Needs—
ELECTRONIC TECHNICIANS

- ★ DEVELOPMENT ENGINEERS
- ★ INSPECTION ENGINEERS
- ★ PHYSICIST
- ★ ELECTRONIC EQUIPMENT TECHNICIANS
- ★ MECHANICAL DRAFTSMEN
- ★ AND OTHERS

A real opportunity for experienced men, particularly with well-balanced backgrounds in acoustics, broadcasting, frequency modulation, ultra high frequencies and special device circuits. Openings exist in designing, development and manufacturing of cathode ray, transmitting and general-purpose tubes; communications, electronic and precision test equipment. Excellent post-war possibilities.

In replying give age, draft status, technical education, training and experience; salary requirements, availability. Enclose photograph. Write direct to:

President

NORTH AMERICAN PHILIPS COMPANY, INC.

Dobbs Ferry, Westchester County, N. Y.

If working in essential industry at highest skill, please do not reply.

WESTERN ELECTRIC CO.

IN PEACE
 Source of supply for the Bell System.
 IN WAR
 Arsenal of communications equipment.

WANTS ELECTRICAL ENGINEERS

for high-frequency electronic work

AND

RADIO ENGINEERS

for design of radio test sets

Write, or apply in person to:

C.R.L.
 Employment Department
 100 CENTRAL AVE.
 KEARNY, N. J.

Release statement & U.S.E.S. consent needed.

MOTOR ENGINEER

Position open for engineer who desires full opportunity to develop own ideas on very interesting new project. Necessary qualifications: originality, sound knowledge of fundamentals, and experience in electronic motor design. Salary open.

Raytheon Mfg. Company

Personnel Department,
 Waltham, Mass.

MECHANICAL DESIGNER:

Man having at least five years' experience designing small parts made on punch presses, screw and die casting machines for large quantity production. If not now employed at highest skill in war production plant, write:

P. R. MALLORY & CO., INC.
 Indianapolis 6, Indiana

RADIO-ELECTRONIC

TESTERS TECHNICIANS

EXCELLENT OPPORTUNITIES

IN A MAJOR POST WAR FIELD

Openings available at our Research Laboratories and Electronic manufacturing unit. Leaders in the design and development of vital electronic equipment for the armed forces.

Essential workers need release statement.

Write, stating experience, education, draft status, salary requirements or apply to

SPERRY

GYROSCOPE CO., INC.

RESEARCH LABS. & ELECTRONIC PLANT
 STEWART AVE. & CLINTON RD.
 GARDEN CITY, NEW YORK

RADIO WRITERS

Resident in the New York Metropolitan area. For part or full-time work on established radio magazine. Capable of writing articles on assigned radio or electronic subjects, expand or digest technical data, press releases, etc., or to carry on research work under editorial direction. Apply

Box 57, Radio-Craft
 25 West Broadway, New York 7, N. Y.

ELECTRICAL TESTERS

MEN AND WOMEN

for radio transmitters and receivers and similar equipment

Young men and women who have been licensed radio amateurs preferred, or those having a good technical knowledge of voice communication and trained in electrical testing of radio equipment, are needed for inspectors and testers.

WESTERN ELECTRIC CO.

IN PEACE
Source of supply for the Bell System
IN WAR
Arsenal of communications equipment

Write, or apply in person to:

C.R.L., Dept. 4816
100 CENTRAL AVE.
KEARNY, N. J.

Mon. through Sat. 8:30 a.m.—5 p.m.
Release statement & U.S.E.S. consent needed.

LABORATORY ASSISTANT

With good background in Electrical and Radio Field Knowledge of Test Equipment Essential. Wonderful Opportunities. Hours Midnight to 8:30 A.M.
STANDARD TRANSFORMER CORPORATION
1500 No. Halsted St., Chicago, Ill.

Chinese telegraphy is complicated by the Chinese written language, which consists of possibly 20,000 characters, instead of the 24 to 30 letters of most European alphabets.

To get around the difficulty, a code number is allotted to each important Chinese character, and the words are sent over the wires or the air in the number code. This may make it easy for the operator, who can send Chinese after learning only the ten cardinal numbers, but delays telegrams because of the time consumed in coding and decoding the text.

Telegraphy in China is now being speeded up to meet the war need by the use of facsimile transmitters, which transmit English, Chinese or a drawing with equal facility. Standard Western Union Telefax machines are being used, and already four of China's most important cities have been linked by the new system, which will presumably be extended with the coming of peace to cover all the main communication routes of the Chinese Republic.

A WAR PRODUCTION JOB
TODAY MAKES WAY FOR
A PEACE JOB TOMORROW

WANTED - ENGINEERS - TECHNICIANS

Radio, Electrical and Mechanical Design Engineers, Draftsmen and Technicians for war and post-war design work.

Engineering degree, or, actual design experience in Communication Radio, Broadcast Receivers, Television and other Electronic Fields is required.

Write giving full details, education, experience in Communication Radio, Broadcast Receivers, Television and other Electronic Fields is required.

Write giving full details, education, experience, draft status and salary desired.
Essential workers need release statement and U.S.E.S. consent.
All inquiries confidential.

Chief Engineer, Electrical Research Laboratories, Inc.
2020 Ridge Avenue, Evanston, Illinois
ERLA-SENTINEL RADIO

TECHNOTES

... THREE WAY A.C.-D.C. BATTERY RADIOS

In these sets the 1A7-GT will often not oscillate over the entire broadcast band. Also, at times it will oscillate during the daytime and will be inoperative at night. This trouble is usually found in sets which use the 117L7-GT, 117M7-GT and 117P7-GT tubes as rectifiers and beam power amplifier, with the cathode of the 117-volt tube connected in series with the 1.4-volt tube filaments to ground.

Either of two conditions may bring about this failure to operate. The 1A7-GT may be weak and not emit enough electrons from the filament to permit the tube to oscillate. This should be checked first. It may seem to be perfect in a tube checker but fail to oscillate under the conditions in the particular receiver.

Then, if the 1A7-GT is found to be in good condition, the next suggested remedy is to rewire the 117-volt socket for a 117N7-GT. If you will refer to the characteristics for the 117P7-GT, you will find that the total plate and screen current is only 4.7 milliamperes. The 1.4-volt tubes require 50 milliamperes to operate properly and when you add to this the discrepancy in design, the possibility (and probably a fact in these days of heavy line loads for war work, etc.) that the power line voltage does not come near the 117 volts which is used in design calculations, the cumulative result is that the 1A7-GT fails to oscillate. The 117N-GT total plate and screen current is but 56 milliamperes under optimum conditions, which would not overload the filaments of the 1.4-volt tubes to the extent of injury. A voltmeter test made when line voltage is highest will assure you that filaments are operating within safe limits.

Caution: There should be at least four of the 1.4-volt tubes in series in order to furnish the required bias voltage for the 117N7-GT.

NORMAN V. CHURCHILL,
Wheaton, Illinois

... BATTERY-TYPE FARM RADIOS

A number of different sets came into the shop with complaints of little or no reception. These were all of the type which used a wet cell as A battery.

In each case battery acid fumes or splashed acid had entered the I.F. transformers through the trimmer-adjusting holes.

To effect a permanent cure, replace the offending I.F.'s. If I.F. transformers are unobtainable, the trimmers only may be replaced, as corrosion in the trimmer is the usual trouble. After repair, put a strip of Scotch tape over the holes in the I.F. shield.

CECIL DEWITT,
Camp Crowder, Mo.

... ZENITH MODEL 6R480

Trouble: Intermittent Reception which is very difficult to locate.

The cause of this difficulty is usually found to be in the voice coil. On a loud signal the set usually goes dead, but after the set has been tuned off awhile and cools it will make a connection again. Resoldering the voice coil connections will clear this up.

GERALD SNIDER,
Marietta, Ohio

... INTERMITTENTLY OPEN FILAMENT

An unusual trouble was experienced with a small Emerson A.C.-D.C. When operated on the bench, the pilot light went on and off symmetrically, something in the fashion of a Christmas-tree flasher. An open tube filament was indicated, but all tubes tested O.K. in the checker.

To save the time required to find the trouble by substitution and elimination, I shunted a ¼-watt, 125-volt neon lamp across the filament terminals of each tube in turn. The 50L6 was found to be the offender. When the tube line opened, the neon lamp lit up, indicating quickly where the defective filament lay.

CHAS. NAZZARO,
Brooklyn, N. Y.

THIS RADIO REALLY WORKS

INDUSTRIAL executives and school principals will be interested in a new panel-type demonstrator unit designed to simplify instruction in radio circuit theory and design, operation and servicing for workers' training programs and school curricula.

A complete 5-tube superheterodyne broadcast receiver, it is assembled on a 30 by 36-inch imprinted panel and mounted in a reinforced hardwood frame 3 inches deep. It may be set up on a table or blackboard, two removable mounting feet providing the proper support. It may also be placed on a wall for vertical observation.

The unit actually operates, and surprisingly good results are obtained through a small speaker mounted on the baffle board. Tubes are of the high voltage filament type and the circuit is wired for 110-volt A.C.-D.C. operation. All parts except the loop are mounted in plain view adjacent to their schematic positions on the panel, which is printed in four colors. Grid circuits are in green, plate circuits are in blue, positive potential (B plus) leads are in red, and the

balance of the circuit is in black, in accordance with RMA standards.

An excellent means for demonstrating trouble shooting and the proper use of test equipment in teaching repair work is the use of multiple snap connectors on studs at points marked "X." Thus, each coil, condenser, or resistor may be opened, or, where it will not damage the unit, shorted out to simulate actual conditions in defective receivers.

Available now to all industrial units, schools and other institutions conducting educational programs, the demonstrator boards come with drilled panel in kit form or completely assembled and wired. Developed and manufactured by the Lafayette Radio Corporation, it contains well over 200 individual pieces.

It is constructed in the main of non-critical materials—note the A.C.-D.C. circuit. Absolute safety, an important factor in working with novices, can be achieved by using a polarized plug and receptacle, so that the receiver ground will always be true earth.

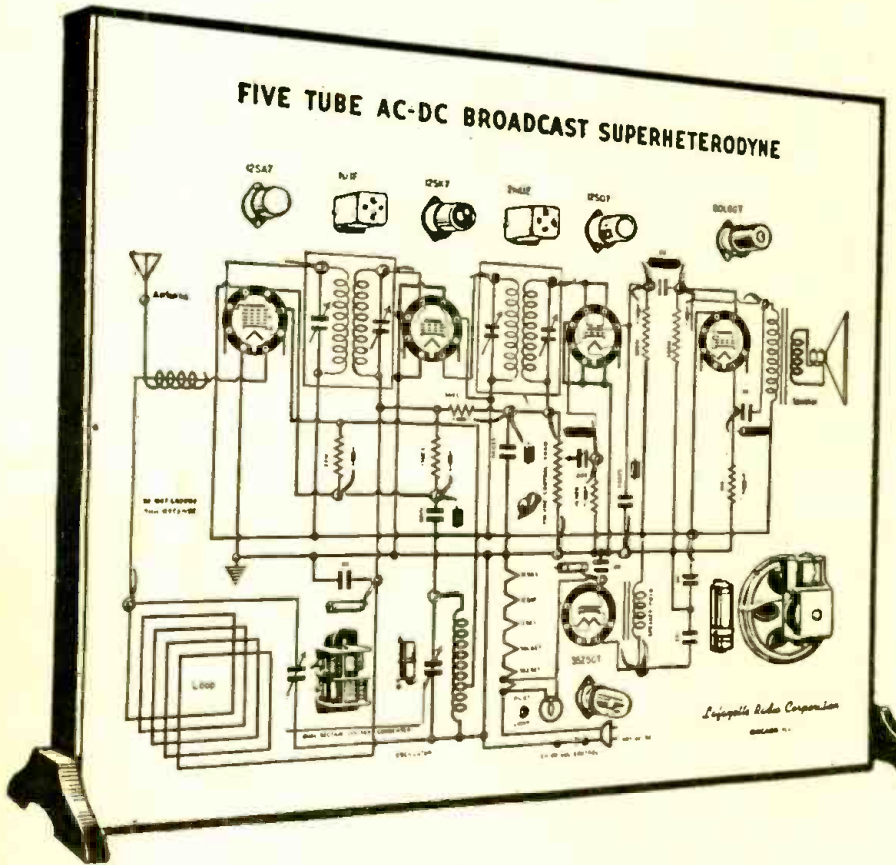

TEST EQUIPMENT EASING UP

TEST-EQUIPMENT manufacturers, who have had difficulty getting components have been assured that an easing of their situation is in sight.

The Army-Navy electronic production agency has arranged for manufacturers of future test equipment to apply to the agency for authority to extend an A-I-p precedence and serial number to component supplies to speed up their deliveries.

Meanwhile unfilled orders for equipment, such as resistors, condensers, switches and potentiometers, have accumulated, and in some instances, committee members reported, delayed deliveries have retarded production as much as 35 per cent.

At the same time, in another field of

electronic equipment manufacture, WPB reported satisfactory progress on its plans for utilizing idle and excess stocks of electronic components for assembly into the sharply expanded program for military electronic equipment for this year. Through what is called the "components recovery plan" the radio and radar division of WPB has managed to "return surplus components to the productive stream," it was stated.

A new radio will be among the first post-war purchases of 2,625,000 American families, interviewers in a recent survey were told.

Short-Cut Mathematics

COMBINED WITH
Practical Mechanics Simplified

NEW 2-in-1 reading course! Now you can learn the speedy, simplified system of calculation used by draftsmen, engineers, accountants, "master minds" on the stage. Learn easy way to multiply 4 figures by 4 figures without using old-fashioned multiplication; add long columns of figures this lightning short-cut method. Learn horsepower, slide rule, micrometer, logarithms, wood measure, puzzles, etc., etc. Large illustrated volume complete with answers, only \$1 postpaid. Satisfaction or refund. Amaze your friends with your magic-like mental powers.

FREE Complete details... mail coupon TODAY!

NELSON CO., 321 So. Wabash, Dept. E-310, Chicago

Please send free details about "Short-Cut Mathematics and Practical Mechanics Simplified." No obligation.

Name _____
Address _____

Inventions Wanted

Patented or Unpatented

We have been successfully selling inventions, patented and unpatented, since 1924. Write us, if you have a practical, useful idea for sale.

CHARTERED INSTITUTE
OF AMERICAN INVENTORS

Dept. 111, 631 Pa. Ave., N.W., Washington, D. C.

GEOPHYSICAL

PROSPECTING

PRINTS

(TREASURE
FINDERS)

50¢ EACH
7 FOR
\$3.

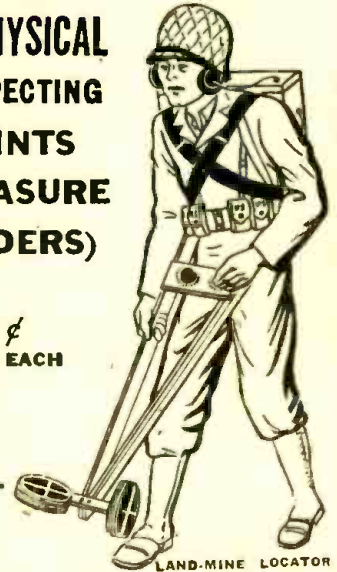

With any one of the modern geophysical methods described in the Blue-Print patterns, radio outfits and instruments can be constructed to locate metal and ore deposits (prospecting); finding lost or buried treasures; metal war relics; sea and land mines and "duds"; mineral deposits; subterranean water veins; oil deposits (under certain circumstances); buried gas and water pipes; tools or other metallic objects sunken in water, etc., etc.

Folder No. 1. Radioteletype Pilot. Construction and use of 2 tube transmitter and 3 tube receiver. Reflected wave principle. Visual and aural signals.
Folder No. 2. Harmonic Frequency Locator. Radiates low frequency wave to receiver. Aural signals.
Folder No. 3. Bent Note Indicator. 2 oscillators. Visual and aural signals.
Folder No. 4. Radio Balance Surveyor. Balanced loop principle. Modulated transmitter. Visual and aural signals.
Folder No. 5. Variable Inductance Monitor. Inductance principle. Aural signals.
Folder No. 6. Huxley's Inductance Balance Explorer. Bridge principle. Aural signals.
Folder No. 7. Radiodyne Prospector. Balanced loop principle. Very large field of penetration. Aural signals.

Each set of blueprints and instructions enclosed in heavy envelope (9 1/2" x 12 1/2"). Blueprints 22" x 34"; eight-page illustrated 8 1/2" x 11" folder of **50c** instructions and construction data. Add 5c for postage.

The complete set of seven folders **\$3.00**
Shipping weight 2 lbs. (add 25c for shipping anywhere in U.S.A.)

Send Stamps, Cash or Money Order to

TECHNIFAX

1917 S. STATE ST. RC-5-44 CHICAGO, ILL.

TECHNIFAX 1917 So. State. Chicago, 16. Ill.

Enclosed herewith \$..... for which mail to address below:

Treasure Finder No. 1, 2, 3, 4, 5, 6, 7.
Complete set of seven folders.

NAME

ADDRESS

CITY STATE RC-5-44

New Direct-Coupled FM - AM AMPLIFIER MANUAL

By **A. C. SHANEY**
Chief Engineer, Amplifier Co. of America

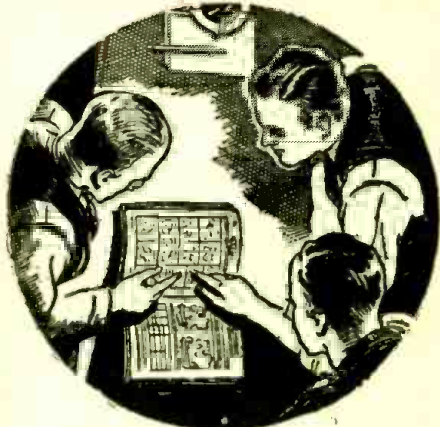

**For the Layman, Serviceman
Recordist and Engineer**

Regardless of whether you are interested in the finest type of phonograph reproduction, high fidelity recording, sound-on-film applications, FM or AM programs, you will find invaluable information in this practical handbook. Written by the leading exponent of direct-coupled amplifiers who has spent more than 10 years improving and perfecting the famous Loftin-White circuit.

**Explains the theory and practical
application of:**

Variable Speed Non-Overloading Push-Pull Expansion
Non-Frequency Discriminating Scratch Suppression
Push-Pull Balanced Direct-Coupled Amplification
Push-Pull High-Frequency Equalization
Push-Pull Low-Frequency Equalization
Push-Pull Volume Compression
Automatic Volume Limitation
Automatic Volume Control
Calibrated V. U. Indicator
Audio Spectrum Control
Remote Control

If you are interested in the latest audio developments, you can't afford to be without this complete compilation of authentic articles on Direct-Coupled Amplifiers. 32 pages 8 1/2" x 11". Over 100 diagrams and illustrations.

Priced to Cover Cost of
Printing and Mailing **25c**

Send U. S. Stamps or Coin

AMPLIFIER CO. of AMERICA

396 BROADWAY

NEW YORK, N. Y.

OLD TUBES

Small Quantity available subject to prior sale. No collection complete without one of these tubes. Get Yours while supply lasts. Tubes certified and sealed in original cartons 18 years ago. Tube constants and operating voltages on carton. Each tube has hand drawn curve sheet enclosed, dated 1925 or 1926, making them authentic.

Types Muselmann 5VC and 3VC Price post paid \$1.00. Muselmann 5VCA Mogul power tube. Price post paid \$1.20.

Type 5VCA was one of the first power tubes to have binding posts on tube base. Also English valves - type DD at 1.00 each. (OSRAM). From private collection of Oran T. McIlvaine, radio tube inventor. We are also interested in buying old tubes made before 1913. Let us know what you have.

ORAN T. McILVAINE, St. Charles, Ill.

PATENTS—TRADE MARKS

Booklet concerning Inventions & Patents Form "Evidence of Conception" with instructions for use and "Schedule of Government and Attorneys Fees"—Free

LANCASTER, ALLWINE & ROMMEL
Registered Patent Attorneys

436 Bowen Bldg. Washington 5, D. C.

A new technique to overcome rapid fading and dead spots on ultra-short-wave broadcasts, as well as the annoying "ghosts" which haunt the television screen, is proposed as a post-war possibility.

Instead of one station trying to feed a program to a given district, it is suggested that a number of stations be situated around the area to be covered. Thus a populous city could be ringed with a circle of FM or television stations and the programs "centercasted" inward.

508

The Mail Bag

IS PERSONAL LIBERTY ENDANGERED?

Dear Editor:

Replying to F. W. Fee's letter in the February issue, we heartily disagree with his principles which opposes every individual's rights of personal liberty, the right of contractual engagement and free enterprise. His letter states that only licensed shops should be permitted to buy supplies. What is he trying to do, choke out all amateurs and experimenters by prohibitive costs? Many of these amateurs will be the technicians of the future, yet Mr. Fee's plan will squelch them before they even get started! His and all such plans would materially reduce the business of the small distributor, all of which would tend to force the little man in the industry out.

Licensing of servicemen would soon bring about a servicemen's union which would be highly undesirable in this profession. To what combination of brass hat racketeering union officials and crooked politicians would Mr. Fee assign the rights of the free citizens of this country engaged in the radio profession? All such methods are steps to socialism.

We would like to suggest that you publish articles on construction of equipment and less of this post war dreaming. We appreciate your magazine and hope that it will soon return to its former high standard.

CLAY THOMSON,
RALPH EMERSON,
Palo Alto, Calif.

"RADIO-CRAFT" ANSWERS HIS NEEDS

Dear Editor:

I look with favor upon your clearly defined attitude regarding the type of article you intend to print. Your own editorial comments, the printed comments from your readers, as well as the interesting material in this month's magazine (January) indicate that you cater to those interested in radio generally, experimental as well as radio service. Those individuals interested exclusively in radio service, in mathematical theory, or in industrial electronics, to mention a few fields, will find specialized magazines in their subject of special interest. I am not strictly a beginner, but find your articles as useful as workshop experience or a lecture in principles.

Only yesterday a friend of mine asked if

I knew the principles of the differential microphone (the Schickelgruber). At the earliest opportunity I will show him the article in the January issue, which will make the principle as clear to him as it has been made for me. I was interested to note (p. 199) that Hugo Gernsback founded "Radio News" in 1919. "Radio Month in Review" is one of the best digests I have come across in any magazine. I hope it will continue as it is.

One other item that I consider particularly commendable is your newly inaugurated listing of "Available Radio-Electronic Literature."

ROY A. ELKIND,
New York, N. Y.

TESTS FOR SERVICE LICENSES URGED

Dear Editor:

The Mail Bag always is read first every time I get a new *Radio-Craft*. I enjoy it a great deal, especially letters from fellow servicemen advocating a license for radio repairmen.

There seems to be quite a controversy about the type of test that should be given when applying for a license. I think a test similar to the FCC's Commercial Operator License would enable good repairmen to qualify. The others of course would have to "wise up" or try their luck in a different profession.

This seems to be the only way to elimi-

nate screw-driver mechanics and "gyps", both of which have given a very bad name to the radio profession. A competent radio-man can't afford to gyp a customer because his reputation would suffer accordingly and finally cause him losses.

Naturally, when the war is over I intend to go back into the radio repair business and hope by that time a license will be required. Especially because there will be a lot of men trained in radio by the Army and a license would identify those capable of upholding the reputation of the profession.

EDWARD NEUMANN,
Cincinnati, Ohio.

BEGINNERS CAN GET EXPERIENCE

Dear Editor:

Mr. Adams has the same idea that I suggested to my congressman some seven years ago.

I have been in the radio business since 1924 except for a few years that I attended college. I have run into the same problems that Mr. Adams has. Customers used to come into the shop and want their radio checked to see what the trouble was. After it was located, some of them would say, "I can get the parts wholesale and you put them in!"

As for the beginners—I was once a beginner myself, but I didn't start servicing till I had taken a course and knew enough to pass any reasonable test that might be given for the proposed license. Beginners would be well advised to arrange to work with a regular serviceman in their spare time and then take up a good course in radio or study elementary texts before going into the business.

RALPH L. MORRISON,
Yorktown, Va.

METEOROLOGY FOR ALL

(Continued from page 479)

can be incorporated into a combination volt-milliammeter. The construction of this unit is left to the ingenuity of the reader.

TABLE OF FORMULAS

FORMULA A—Finding shunt resistance

$$R_x = \frac{R_m}{n-1}$$

Where— R_x = desired shunt resistance
 R_m = internal resistance of meter
 n = scale multiplication factor

EXAMPLE: An 0-5 ma. meter with an internal resistance of 14 ohms is to have its range extended to 50 ma. Find the resistance of shunt necessary.

$R_m = 14$ ohms; $n = 10$. Using the above formula,

$$R_x = \frac{14}{10-1} = 1.55 \text{ ohms.}$$

FORMULA B—Finding the multiplier resistance

$$R = \frac{1000E}{I}$$

Where— R = desired multiplier resistance
 E = full scale voltage
 I = full scale current in milliamperes

EXAMPLE: An 0-1 ma. meter is to be converted to a voltmeter reading full scale, 100 volts. Find the value of the multiplier resistance.

$$\frac{1000 \times 100}{1} = 100,000 \text{ ohms.}$$

"Giveaway" programs, in which the station offers money prizes to telephoned listeners, are under combined attack of radio and advertising interests, as a nuisance type of entertainment uninteresting to the serious listener and unprofitable to the radio advertiser.

\$3.00 FOR YOUR IDEA

RADIO-CRAFT, as you will have noticed, prints a number of radio cartoons, which we intend to keep on publishing every month indefinitely. We invite our readers to contribute to this feature by sending in their ideas of humorous radio ideas which can be used in cartoon form. It is not necessary that you draw a sketch, but you may do so if you so desire.

RADIO-CRAFT will pay \$3.00 for each original idea submitted and accepted.

We cannot return ideas to this department nor can we enter into correspondence in connection with them. Checks are payable on acceptance.

Address all entries to RADIO CARTOONS, c/o RADIO-CRAFT, 25 West Broadway, New York 7, N. Y.

NOW WESTON MODEL 785 INDUSTRIAL CIRCUIT TESTER!

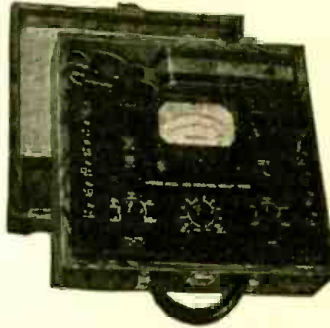

Tests Insulation and Cable Covering Resistance Values as Well!

With this new, compact unit which fits into the spare compartment and connects into the ohmmeter circuit with a pair of leads, Model 785 now provides for resistance measurements up to a value of 900 megohms. Thus the broad range coverage of this versatile maintenance tool now is as follows:

DC VOLTAGE . . . 0-1/10/50/200/500/1000 volts—20,000 ohms per volt. (*5000 volt range with external multiplier.)

AC VOLTAGE . . . 0-5/15/30/150/300/750 volts—1000 ohms per volt.

DC CURRENT . . . 0-50 microamperes. 1/10/100 milliamperes, 1 ampere and

10 amperes (*ranges above 10 amperes with external shunts).

AC CURRENT . . . self-contained ranges 0-5/15/50/10 amperes (*higher ranges with an external current transformer).

RESISTANCE . . . 0-3000, 0-30,000, 0-300,000 ohms, 0-3 megohms, 0 to 30 megohms (self-contained batteries). 0-900 megohms (*with compact Model 792 Resistance Tester shown in illustration).

*Extra equipment on special order.

For complete facts on Model 785 write Weston Electrical Instrument Corp., 599 Frelinghuysen Ave., Newark, N. J.

WESTON Instruments

ORDER YOUR COPY TODAY

Limited Supply Available

Volume 2 of the OFFICIAL REFRIGERATION MANUAL, which was published in 1935, contains service data and information of value to everyone interested in refrigeration.

There has been a tremendous demand for this manual, especially during the last year. This has been due to the discontinuance of new models for the duration of the present emergency and the necessity of servicing all old refrigerators and keeping them in service as long as possible.

You will find this Manual very helpful in repairing refrigerators and keeping them in good working order until new refrigerators can again be manufactured.

OVER 350 PAGES
OVER 300 DIAGRAMS

To order this Refrigeration Manual—

MAIL COUPON
TODAY FOR YOUR
COPY

RADCRAFT PUBLICATIONS, INC.
25 West Broadway, New York 7, N. Y.

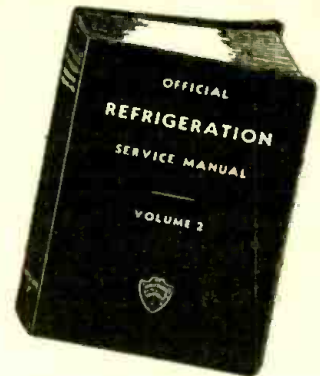

Partial Contents

Theory and Fundamental Laws
 Methods of Refrigeration
 Refrigerants, Lubricants and Brines
 Handling and Storage of Refrigerants
 Compression System of Refrigeration
 Liquid Throttle Devices Refrigeration Systems
 Electric Control Devices
 Compressors, Types, Seals, Valves, Capacities
 Evaporators and Cooling Units Service Tools
 Commercial Unit Specifications
 Servicing Refrigeration Apparatus
 Servicing Low Side Float Valve Systems
 Servicing High Side Float Valve Systems
 Servicing Expansion Valve Systems
 Servicing Thermostatic Valve Systems
 Servicing Restrictor and Capillary Tube Systems
 Charging Systems with Refrigerant
 Electrical Service; Motors, Fuses, Hookups
 Estimating Refrigeration Loads

RADCRAFT PUBLICATIONS, INC.
25 West Broadway, New York 7, N. Y.

RC5-44

Gentlemen—Enclosed you will find my remittance of \$5.00, for which please send me one copy of the OFFICIAL REFRIGERATION SERVICE MANUAL, (Volume II). I understand that this book is to be shipped to me POSTAGE PREPAID.

Name

Please Print Clearly

Address

CITY State

NOW—A REALLY HIGH-POWERED— Radio Engineering Library

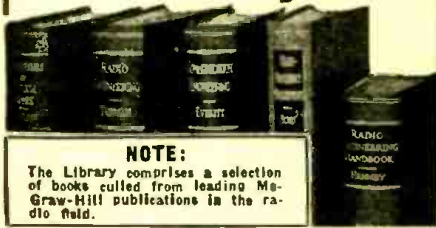

NOTE:

The Library comprises a selection of books culled from leading McGraw-Hill publications in the radio field.

- especially selected by radio specialists of McGraw-Hill publications
- to give most complete, dependable coverage of fields needed by all whose fields are grounded on radio fundamentals
- available at a special price and terms

THESE books cover circuit phenomena, tube theory, networks, measurements, and other subjects—give specialized treatments of all fields of practical design and application. They are books of recognized position in the literature—books you will refer to and be referred to often. If you are a practical designer, researcher or engineer in any field based on radio, you want these books for the help they give in hundreds of problems throughout the whole field of radio engineering.

6 VOLUMES, 3319 PAGES, 2289 ILLUSTRATIONS

1. Eastman's FUNDAMENTALS OF VACUUM TUBES
2. Terman's RADIO ENGINEERING
3. Everitt's COMMUNICATION ENGINEERING
4. Hund's HIGH FREQUENCY MEASUREMENTS
5. Henney's RADIO ENGINEERING HANDBOOK

10 days' examination. Easy terms. Special price under this offer less than books bought separately. Add these standard works to your library now; pay small monthly installments, while you use the books.

10 DAYS' FREE EXAMINATION—SEND COUPON

McGraw-Hill Book Co., 330 W. 42nd St. New York 18

Send me Radio Engineering Library, 5 vols., for 10 days' examination on approval. In 10 days I will send \$3.00 plus few cents postage, and \$3.00 monthly till \$24.00 is paid, or return books postpaid. (We pay postage on orders accompanied by remittance of first installment.)

Name

Address

City and State

Position

Company RC-5-44

\$1.00—TRANSMITTER BUTTONS—\$1.00

One of the most versatile of all electrical devices is the carbon grain transmitter button. With this button many interesting experiments can be performed. They are ideal for telephones, dictaphones, detectors and the like. Ten cents in coin will bring you a 12-page booklet showing more than 50 uses for this button. There are more than 50 diagrams and illustrations shown. \$1.00 brings you post paid one of these buttons together with the booklet. Order at once before the supply is exhausted.

ELECTRONIC PRODUCTS CO. St. Charles, Ill.

OPPORTUNITY AD-LETS

Advertisements in this section cost 20 cents a word for each insertion. Name, address and initials must be included at the above rate. Cash should accompany all classified advertisements unless placed by an accredited advertising agency. No advertisement for less than ten words accepted. Ten percent discount six issues, twenty percent for twelve issues. Objectionable or misleading advertisements not accepted. Advertisements for June, 1944, issue must reach us not later than April 28, 1944.

Radio-Craft • 25 W. 51st • New York 7, N. Y.

USED CORRESPONDENCE COURSES AND TECHNICAL Books Bought, Sold, Rented, Catalog Free, Educational Exchange, Henagar, Alabama.

PREPARE NOW FOR TREMENDOUS OPPORTUNITIES in new fields of radio after the war. Training for Federal licenses. Write for particulars, American Radio Institute, 44 East 23rd Street, New York 10, N. Y.

SELENIUM RECTIFIERS MAXIMUM LOAD 2½ AMPERES 50 volts \$3.49. Milton Burman, 105 Avondale, Jackson, Michigan.

Radio-electronic workers attending night courses at one of the country's biggest telephone plants prefer mathematics above all other subjects, reports Stromberg-Carlson. Simple electrical theory runs second.

SIMPLEST TRANSMITTER

LATEST thing in the code-practice line is a new blinker, put out by Einson-Freeman Co. It might be called the "crystal set" of blinkers, since it uses no lamps or other power, and does not even require a mirror to concentrate the rays of the sun.

An imitation of the shuttered lamp used for visual signalling in the Navy, the pocket blinker is essentially a piece of slotted cardboard which slides over a black-and-white striped surface. The slots and stripes are the same width, the whole is built up in a form a little larger than a book match packet, with a piece of plastic in the back as a spring, holding the slotted cardboard in a fixed position, which permits no white to show through. When pressed, the slots move over, exposing white strips. Pressure relieved, the surface becomes all-black again. Seen from a distance of several feet, signals from the device look like a number of white flashes.

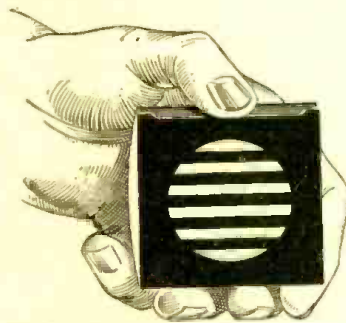

With the virtual shut-down of radio at sea, convoys depend entirely on wig-wag, the blinker and the hand-operated signalling "gun" which confines the flashlight beam to a narrow range. Thus the importance of learning blinker code is apparent, and surprisingly enough, more than one 30-words-per-minute man (between the cans) is unable to follow the blinker light 5 words per. With a couple of these ingenious devices, a pair of learners can practice anywhere, at any time, employing otherwise useless moments in developing what may turn out to be a life-saving technique.

A few of these little blinkers are available, and may be obtained from this office. Cost is 10c each. Address: Pocket Blinker, c/o Radio-Craft, 25 West Broadway, New York 7, N. Y.

Sterilamp in the brooder house has reduced infant chick mortality by more than 60 per cent in recent installations, according to *Wartime Engineering*. Newly hatched chicks crowd together in warm, humid rooms under conditions ideal for the spread of germ-borne infections. The germicidal lamps keep the air sterile, kill all germs struck by their rays, thus preventing epidemics.

The Navy's new ultra-sensitive echosounding devices, now used to detect submarines, may after the war be used to help deep-sea fishermen according to Harold Ickes, speaking in his capacity of Coordinator of Fisheries.

"This deep-sea radar," it was stated, "is able not only to find the fish, but roughly determine the size of the school, its course and speed."

Index to advertisers

Aerovox Corporation.....	498
Allied Radio Corp.....	496
Amplifier Company of America.....	508
Audel & Company.....	457
Burstein-Applebee.....	503
Cannon Company, C. F.....	503
Chartered Institute of American Inventors.....	507
Chicago Novelty Co., Inc.....	495
DeForest's Training, Inc.....	493
Echophone.....	456
Electronic Products Co.....	508, 510
Erla-Sentinel Radio.....	506
Federal Telephone & Telegraph.....	504
Galvin Manufacturing Co.....	
Inside front cover	
General Electric Co.....	492
Gold Shield Products.....	499
Hallcrafters, Inc.....	451, 452
Harrison Radio.....	497
Henry Radio.....	497
Hudson Specialties.....	498, 502
International Resistance Co. Back cover	
Lafayette Radio Corp.....	500
Lancaster, Allwine & Rommel.....	508
Maedel Publishing House.....	503
Mallory, P. R.....	505
Meissner Mfg. Co.....	455
McGraw-Hill Book Co.....	510
National Radio Institute.....	449
National Union Radio Corporation.....	
454, 504	
Nelson Company.....	503, 507
North American Philips Co.....	505
Onan & Sons, D. W.....	499
Opportunity Adlets.....	510

RADIO SCHOOL DIRECTORY

Page 512

Candler System
Capitol Radio Engineering Institute
Commercial Radio Institute
Lincoln Engineering School
New York Y.M.C.A.
Radio & Television Institute
RCA Institutes

Radcraft Publications, Inc.....	501, 509
Radio Corporation of America.....	458
Radio & Technical Division of Murray Hill Books, Inc.....	483
Raytheon Mfg. Co.....	505
Shure Brothers.....	499
Sperry Gyroscope.....	505
Sprague Products Co.....	485
Sprayberry Academy of Radio.....	453
Supreme Publications Inside back cover	
Supreme Instruments Corp.....	494
Standard Transformer Corp.....	506
Sylvania Electric Co.....	490, 504
Technifax.....	507
Triplett.....	495
University Laboratories.....	503
Western Electric Co.....	505, 506
Weston Electrical Inst. Co.....	509
Wiley & Sons, Inc., John.....	487

(While every precaution is taken to insure accuracy, we cannot guarantee against the possibility of an occasional change or omission in the preparation of this index.)

BOOK REVIEWS

THE TECHNIQUE OF RADIO DESIGN, by E. E. Zepler. Stiff cloth covers, 5½ x 8½ inches, 312 pages. Price \$3.50.

RADIO RECEIVER DESIGN, by K. R. Sturley. Stiff cloth covers, 5½ x 8½ inches, 435 pages. (Part One—Radio Frequency Amplification and Detection.) Price \$4.50. Both published by John Wiley & Sons.

The two books on the same subject and by the same publisher are also alike in that they are American issues of works originally published in England.

Intended for the radio receiver design engineer, both books give the computations necessary for calculating the values of parts, couplings and other constants. Both combine mathematical calculations with text matter concerning practical considerations which might modify the computations. It is pointed out in the preface to "The Technique of Radio Design" that the work of designing a radio is by no means finished on paper: "The real technique of experimental work starts where unexpected complications occur; where a circuit behaves in a manner not readily predicted from its circuit diagram. The technique of design, on the other hand, consists in foreseeing complications and in being able to work out on paper the electrical circuit and the mechanical construction so that serious trouble is not likely to occur."

"The Technique of Radio Design" covers more ground in fewer pages, and is therefore noticeably more compact. It does, however, devote a chapter to screening (shielding), another to hum and spurious beats, one to distortion and one to parasitic resonances, all of which are of great interest to the radio designer, but are not as susceptible to mathematical treatment as are, for example, antenna coupling or amplifier stages. The same may be said of the chapter on undesired feedback.

"Radio Receiver Design" confines itself rather more closely to the direct problems of design, devoting more space to each element. Antenna coupling, which in the other book is covered in 20 pages, receives 70 in this. The same relations hold roughly in the chapters on frequency changing and intermediate and radio frequency amplifiers. Audio problems are intentionally left for a Part II, to be published.

Though these books are intended to cover the same subject, their difference of emphasis—the wider range of the one and the more intensive treatment of the other—will assure both a place on the shelf of the alert design engineer.

MATHEMATICS DICTIONARY, by Glenn James, assisted by Robert C. James. (Revised edition). Published by The Digest Press. Stiff leatherette-finished cover, size 6 x 9 inches, 273 pages, plus a 46-page appendix. Price \$3.00.

To quote the title page, the Mathematics Dictionary "gives the meaning of the basic mathematical words and phrases, including an exhaustive covering of the terms from Arithmetic through the Calculus and the technical terms commonly used in the applications of these subjects." The standard formulas are also included, not only straight mathematical formulas having their place, but also those for solving triangles, computing lengths and areas as well as volumes of variously-shaped solids. Compound in-

terest and annuity formulas are also listed. Definitions of all mathematical terms, from the elementary to the most complex, are given.

It is the experience of all who have to do with mathematics, and especially to the practical man who must turn the bulk of his attention to other subjects, that it is impossible to carry in the head all the mass of facts, formulas and information picked up during the years of training. The efficient man is he who knows where to look for such information, not the one who tries to carry it with him. Many persons have developed a system by which memory assists in turning up the required information from a stack of old textbooks. The Dictionary should make much of this unnecessary.

The Appendix includes tables of common logarithms, trigonometric functions and their logarithms, compound interest and annuity tables, mortality tables and tables of square and cube roots, denominate numbers, differentiation formulas and integral tables.

ELECTRICITY AND ITS APPLICATION TO MILITARY AND CIVILIAN LIFE, by Charles A. Riide. Published by Harcourt, Brace and Co. Stiff cloth covers, 6¾ x 9½ inches, 466 pages. Price \$2.50.

Very popularly written, the style of this book is such as to keep the student reading, and it might well be recommended to the industrialist or other non-technical man who needs a greater knowledge of electricity and electronics, yet is not inclined to study a heavy text.

Electronics is the central theme of the book, in spite of its name. From the outset, as the author states in the preface, "One central theme unifies the book: the control of electrons." In accordance with this aim, electricity is introduced to the

student in the electron form. Much more than the usual space is given to discussing the chemistry of the primary cell, also with the idea of showing up the electronic nature of the device. The chapter becomes an elementary treatise on chemistry. A chapter on physics also appears, under the heading: "Energy may be transformed from any one of its forms to any other." This introduces the chapter on electric generators.

The language is simple. This simplicity is maintained through discussions of inductance, phase and vacuum-tube action in which many texts "written for beginners" have recourse to clichés, the very understanding of which (to say nothing of the subject discussed) presupposes several years of radio experience.

The highly original nature of the work, its treatment of electrical and electronic apparatus from the point of view of its usefulness to man, and the large amount of explanatory and narrative material which is responsible for its distinctive style, will make this book valuable not only to the non-technical learner but to the teacher in search of supplementary material to inject into elementary electricity and electronics courses.

The illustrations, both photographs and drawings, are also well worth mention, both because of their quantity and quality. Another feature of the book is its chapters on X-ray, fluorescent lamps and cathode-ray tubes. The material on X-ray is probably the most extensive so far published in as elementary a form.

Appendices, including tables of the properties of some more common elements, electromotive forces of metals, resistivity of metal wires (based on No. 22 A.W.G. and compared to copper) resistance of nickel-chromium and currents required to heat resistor wire in air, occupy 12 pages at the back of the book.



Suggested by Franklin Williams, W6 ULE, Glendale, Calif.
"You say it happens every time Frank Sinatra sings?"

Radio School Directory

TO OUR READERS—NOW IS THE TIME TO TAKE UP RADIO!

NOW, more than ever before America needs trained radio men. The Army, the Navy and the Air Force are continuously on the lookout for men who have had training in radio. Scores of war industries require radio men in various capacities throughout the country. There now is and there will be a great shortage of radio men for years to come. Reputable schools of Radio advertise to help you.

SLIDE RULE OR SCREWDRIVER

... which will YOU be using 2 years from now?

Add Technical Training to Your Present Experience—THEN Get That BETTER Radio Job You Want!

Thousands of new men have joined the ranks of the radio industry for the duration. But after the war, even more thousands will return from the armed forces. War production will settle down to supplying civilian needs.

Where will you fit into this picture? If you are wise, you will look ahead and prepare for the good-paying jobs in radio-electronics and industrial electronics. It is up to you to decide if you will be a "screwdriver" mechanic or a real technician in a responsible engineering position.

CREI can help you prepare by providing you with a proven program of home study training that will increase your technical ability and equip you to advance to the better-paying radio-electronics jobs that offer security and opportunity. The facts about CREI and what it can do for you are printed in an interesting, new 36-page booklet. It is well worth your reading. Send for it today.

• WRITE FOR FREE 36-PAGE BOOKLET

If you have had professional or amateur radio experience and want to make more money—let us prove to you we have something you need to qualify for a better radio job. To help us intelligently answer your inquiry—PLEASE STATE BRIEFLY YOUR BACKGROUND OF EXPERIENCE, EDUCATION AND PRESENT POSITION.



CAPITOL RADIO ENGINEERING INSTITUTE

Home Study Courses in Practical Radio Engineering for Professional Self-Improvement

Dept. RC-5, 3224-16th St., N. W. WASHINGTON 10, D. C.

Contractors to the U. S. Navy, Coast Guard and Canadian Broadcasting Corp. Producers of Well-Trained Technical Radlomen for Industry

**Pre-Induction
RADIO COURSES**

for Civilians and those entering Military Services. New classes now starting for men and women.

• RADIO OPERATING • CODE
• RADIO SERVICING • ELECTRONICS

New York Y.M.C.A. Schools
4 W. 64th Street New York City



Send for FREE 52-page Book. It shows that "crack" operators rely on something besides practice to develop their high speeds and proficiency. It explains the "knack" of sound-sense and sound-consciousness—the secret of speedy sending and receiving. Once you acquire these mental processes, reading code becomes almost second nature to you. The Candler System, endorsed by telegraph champions, will train you quickly to be a High-Speed Radio Operator or Amateur. If you want s-p-e-e-d and proficiency—send for this revealing book now.

CANDLER SYSTEM CO. Box 928, Dept. 3E, Denver, Colo., U.S.A.
And at 121 Kingsway, London, W.C. 2, England

RADIO . . . TELEVISION ELECTRONICS

TRAIN NOW for postwar opportunities in this VAST, NEW field! Classes day and evening. Call daily 9-9—Sat. 9-2, or write Dept. RC.

RADIO-TELEVISION INSTITUTE
480 Lexington Ave., (46th St.) PLaza 3-4585
Licensed by N. Y. State

COMMERCIAL RADIO INSTITUTE

A radio training center for twenty-three years.

RESIDENT COURSES ONLY

Pre-Induction, Broadcast, Service, Aeronautical and Radio telegraphy classes now forming for June 19th. Literature upon request.

Dept. C., 38 West Biddle St., Baltimore 1, Md.

RADIO TECHNOLOGY

RCA Institute offers an intensive two-year course of high standard embracing all phases of Radio and Television. Practical training with modern equipment. Also shorter, specialized courses in Commercial Radio Operating, Radio and Television Servicing, and Aviation Communications. For Free Catalog write Dept. RC-44.

RCA INSTITUTES, Inc.
A RCA Corporation of America Service
75 VARICK STREET NEW YORK 13, N. Y.

Correspondence Courses in
RADIO and ELECTRICAL ENGINEERING

ELECTRICAL ENGINEERING Get good grasp of wide electrical field. Prepare yourself at Low Cost for secure future. Modern, simplified, you can understand quickly.

RADIO ENGINEERING Extra fine course in radio, publishing, photo-electric work. Headdress, photo-electric work. Trains you to be super-service man, real vacuum tube technician. Servicemen needed badly. Diploma on completion. Tuition \$25, either course. Deferred payment plan.

FREE Get copies of school catalogs, student magazines, complete details. SEND NOW!

LINCOLN ENGINEERING SCHOOL Franklin Stn., Box 61, C63 WASHINGTON, D. C. (Formerly at Lincoln, Nebr.)

DuMont Television station, W2XWV, has opened a second studio in New York City, becoming the world's first television station with more than one studio.

NEW CRYSTAL CHECKER USES AIR-FLOW GAGE

AN interesting device used for rapid checking of crystals is the Precisionaire air-flow gage. In this gage compressed air from the regular plant supply enters through the back, travels through a vertical transparent indicator tube, then out to the gaging spindle, where the work is done. The column of air flows over the crystal, through an orifice whose size is determined by the "gaging block" used. A number of these are seen in the picture. By using gaging blocks of different thickness, crystals for different frequencies can be checked.

Since the amount of air flow is controlled by the orifice between the surface of the crystal and the gaging block, obviously a crystal thicker than the standard will slow down the air flow, whereas if the crystal is thinner, more air will flow past it. The speed of air flow is indicated by a float in the vertical transparent tube. A standard crystal is placed in the gaging spindle and the height of the float noted. Then it is only necessary to check other crystals against the first one.

In grinding blanks, etc., where a certain amount of tolerance is permitted, two standards are used—one for the greatest allowable thickness and one for the least. The position of the float is marked for each by setting one of the sliding tabs (seen to the right of the vertical tube) against it. (The float may be seen as a spot near the lower tab.) Then crystals can be very speedily checked by simply noting the position of the float. If it is between the two tabs, it is within the required tolerance.

The Precisionaire was not originally developed for crystal measurement, and may be used in a wide variety of applications by adapting the gaging spindle to the required job.



How the Sheffield Precisionaire looks in action. The float may be seen as a small black dot a little above the lower "tolerance tab."

Earliest use of magnetic effects, according to Chinese records, was in 2,364 BC. The Emperor Hwang-ti guided his army through fogs with the help of a figure mounted on his chariot. The outstretched arm of this figure always pointed south, and to this day the compass is known in China as the "south pointing indicator."

RADIO-ELECTRONICS

HOME-STUDY COURSE

IN 3 BIG MANUALS

8½ x 11 in.
50 LARGE LESSONS
New 1944 Edition



M. Beltman, teacher and author of many books, directed this preparation. Instructions to help you study at home included in the narrow column on each page.



ONLY
\$3.95
COMPLETE
3 VOLUMES
50 Lessons

GREATEST BARGAIN IN RADIO-ELECTRONIC TRAINING

Get a complete course of training in practical radio and electronics for less than the cost of a single book. The fifty large lessons, making up the course in 3 volumes, are simple to follow, easy to master and apply. Many drawings, examples, diagrams, and instructor's suggestions (in the side column, on each page) help you move along quickly and find learning interesting fun. Review questions at the end of each lesson permit you to check your progress. You enjoy learning important radio and electronic facts. In a surprisingly short time, you are ready to do highly skilled radio repairing, building of electronic equipment, or hundreds of other War-winning tasks in the growing Electronic and Radio industries.

MANY LESSONS ON RADIO REPAIRING

Volume 3, of the course, includes lessons, service hints, case histories, and trouble-shooting charts which will show you how to repair all radio sets quickly and easily. This material alone is worth many times the low price of \$3.95, for the complete 3-Volume course. Send no-risk order coupon today. Look over and use these lessons for 10-days without obligation. You have everything to gain—and nothing to lose.

These lessons will tell you all about

Meters, Microphones, Power Supplies, Test Equipment, Circuits, Oscillators, X-Ray, Amplifiers, Facsimile, Photo-cells, Superhets, Television, Recording, Alignment, Detectors, Motor Control, Radio servicing, Electronics in Industry, Gages, Radio circuits, Hints, Testing radio parts, Transmitters, Metal Locators, Operating, Frequency standards, Analyzers, Welding Controls, Tube testers, P.A., High-frequency heating, Beacons, F.M., Tubes, and hundreds of other topics.

Lessons on all Phases of Electronics and Practical Radio

Let this authoritative, easy-to-understand, practical course pave your way into Electronics—the money-making field of the future. Prepare now. Use this training in your spare time to get ahead in a good War-job. Be ready to grab the opportunities in post-war Electronic developments. Let these lessons train you, serve as your teacher and guide, and give you the needed practical time-saving hints on the job. All topics completely indexed—all subjects easy to find. An educational value that cannot be duplicated at any time.

LIMITED QUANTITY

All three volumes of the Practical Radio and Electronics Course have just been printed. Although a large quantity of courses is on hand now, our bargain price will create a tremendous demand. Government (W.P.B. Order L-245) paper limitation policies may prevent reprinting. Better order immediately for examination—no obligation.

SEND TRIAL ORDER COUPON TODAY

Supreme Publications

PUBLISHERS OF RADIO BOOKS, MANUALS, AND DIAGRAMS

328 South Jefferson Street

Chicago, Illinois

AMAZING OFFER

New, 1944, radio-electronic course of 50 large fact-packed lessons; covers every topic of radio and modern electronics; bound in three big manuals and sold complete at the unbelievable bargain price of only \$3.95, nothing else to pay. Now is your chance to take advantage of this amazing money-saving offer. Let this home-study course guide you quickly to an essential high-pay interesting job in a radio plant, or in electronic War industry, or help you open your own radio service shop, or aid you in getting higher rank in the Army. Learn radio and electronics to earn more money now; prepare for the coming after-the-war opportunities in Electronics and Radio.

THREE COURSES IN ONE

You will find this complete training of 50 large lessons is really three distinct courses covering (1) *Practical Radio*, (2) *Applied Electronics*, and (3) *Radio Servicing*. The lessons are clear, practical, interesting, easy to master and use. No special education or previous experience is needed. Notice in the illustration of the manuals (at the left) how the helpful explanations and remarks, in the narrow column on each page, serve as the teacher. These comments guide you over the hard parts, stress the more important points, show you how to perform many self-teaching experiments using any home-radio. There are hundreds of review self-testing questions, 427 drawings, pictures, diagrams, and service hints. These newly prepared lessons will teach you all about basic radio, transmitters, test equipment, radio servicing, and every topic of modern Electronics — photo-cells, X-ray, metal locators, FM, airplane beacons, recording, facsimile, welding controls, television, etc.

BE A RADIO-ELECTRONIC EXPERT

Train quickly, in your spare time and in your own home, for a well-paying interesting job in the expanding two-billion dollar radio-electronic industry. You begin with elementary principles and quickly progress to practical explanations of radio building, servicing, and all branches of Electronics. In these well written 50 lessons, experts from every field of electronics tell you important facts and knowledge which they gained during years of practical experience. These easy-to-follow, well illustrated lessons will give you the useful "know-how" needed to obtain and get ahead on the job. Send coupon today and examine all three volumes in your own home, without obligation.

POST-WAR OPPORTUNITIES IN ELECTRONICS

New electronic applications, devices, and accomplishments, not even imagined a few years ago, are now helping us win the War. Remarkable and unique new civilian uses of electronics and radio will result immediately after the War. The peace-time advancement in the radio-electronic industry will compare with the rise of the auto industry after the last war. Plan and prepare to be in the midst of this opportunity. Let this lowest priced, home-study course give you the needed training.

SENT ON TRIAL FOR 10 DAYS

Take advantage of our no-risk examination offer. Send trial order coupon. You will receive the complete 3-volume Course for 10 days use. Begin your radio-electronic study without cost or obligation. If you are pleased, the complete course of 50 lessons, in three large manuals, is yours to keep for only \$3.95, full price, otherwise it costs you nothing for the examination.

Money-Back Guarantee
You must be entirely satisfied or your money will be immediately refunded. You are permitted to make full use of the course for 10 days, on a trial basis.
Supreme Publications

NO RISK TRIAL ORDER COUPON

SUPREME PUBLICATIONS, 328 S. Jefferson St., Chicago 6, Illinois
Ship the complete 3-Volume Practical Radio and Electronics Course for 10 days examination.

- I am enclosing \$3.95, full price, send postpaid.
- Send C.O.D. I am enclosing \$..... deposit.

I must be satisfied or you will refund my money in full.

Name:

Address:



This will give me a fine chance to enlarge that end of the house

How to Behave in a Storm by Don Herold

Any upset may be an opportunity to grow—and remodel.

It may be awfully uncomfortable—but it can be darned valuable.

Last summer, lightning struck our summer cottage and burned off the south end. Well, it gave us a chance to enlarge our living room.

This war hurts a lot of us. But it is going to give many folks a chance to get some perspective on themselves.

A lot of radio service men are in a terrible stew right now. Parts and help are hard to get. It's a mess!



PHOTO OF A RADIO SERVICE MAN THROWING AWAY POST-WAR BUSINESS

But, at least, it's different! And it can be stimulating. And after it's all over, you can have things different.

Maybe this is the time to revise your shop—straighten it up—switch it around—get it spic and span.

This certainly is the time to make postwar plans—to think of a future twice as big as your past—to start to get wise on coming new products in radio and allied lines. And it is a time to make

friendly prospects out of customers in trouble—to help boom your business in those days to come.

As a typical consumer, I'm itching for better postwar radio equipment and all the other new electrical gadgets that are on the way.

"I'm going to tidy up the place and tidy up my mind"



And, incidentally, I have more confidence in dealers who let it be known that they string with famous manufacturers and use high grade parts—for instance INTERNATIONAL RESISTANCE UNITS.

No. 4 in a series of special messages prepared by America's famous business writer, humorist and cartoonist, Don Herold. . . In sponsoring these Don Herold "broadcasts," IRC pays tribute to the thousands of Radio Service Men who, whenever possible, specify and use IRC resistance units in their work.



INTERNATIONAL RESISTANCE CO.

401 N. Broad St. Philadelphia 8, Pa

IRC makes more types of resistance units in more shapes for more applications than any other manufacturer in the world.

